

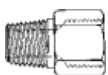

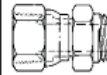

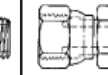





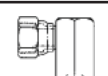

# CENTRAL HYDRAULICS INC.

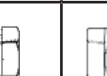
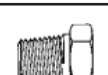
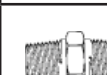





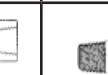



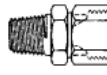

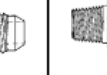
•Daytona Beach •Cocoa •Leesburg •Ocala •Tampa 1-800-264-9571

## Fittings and Adapters





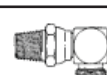









### NPT to NPT FITTINGS

 2040	 2045	 2046	 2047	 2252
 2048	 2049	 2080	 2081	 2096
 2082	 2083	 2085	 2087	 2092
 2088	 2089	 2090	 2091	

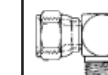

### NPT to JIC FITTINGS

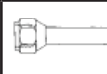
 2018	 2021	 2022	 2023
 2024	 2025	 2028	 2030
 2031	 2239	 2240	 2242
 2249	 2250	 202411	



### JIC to JIC FITTINGS

 2020	 2027	 2033	 2039
 2041	 2043	 2070	 2071
 2406	 203101	 203102	 210292
 500454	 504095	 900599	

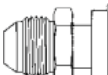



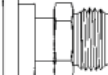

### CODE 61 to JIC

 500023	 500024
 500025	







### CODE 62 to JIC

 ff5539	 ff5540
 ff5541	

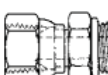
### ORB to JIC FITTINGS

 2061	 2062	 202702
 203003	 203005	 206209

### NPT to ORB FITTINGS

 2066	 2067	 2068
 2216	 2246	 206801