

**EAT•N**

**Hydraulics**

**Quick Disconnect Couplings**



# Serving your industry with quality fluid conveying products



**Construction**



**Forestry**



**Public Safety**



**Utility**



**Marine and Defense**



**Oil and Gas**



**Transportation**



**Steel**



**Machine Tool**

Description	Page
<b>Air Couplings</b>	
FD40 Series – Interchange	17
FD41 Series – Interchange	19
FD43 Series – Interchange	21
<b>Fluid Transfer and Hydraulic</b>	
FD35 Series – Arc Latch, High Pressure	27
FD42 Series – Interchange	30
FD45 Series – Interchange – Steel	33
FD45 Series – Interchange – Brass	37
FD45 Series – Interchange – Stainless Steel	40
FD48 Series – Interchange	44
FD49 Series – HTMA Interchange	46
5100 Series – Threaded, Low Spill	49
5600 Series – General Purpose	57
FD86 Series – DryBreak, High Impulse	69
FD89 Series – Flush-Face, Couplings	72

Description	Page
<b>Fluid Transfer and Refrigerant</b>	
5400 Series – Low Air Inclusion, Low Fluid Loss	52
<b>Hydraulic Farm</b>	
FD70 Series – Male Tip – Deere	68
FD71 Series – Push to Connect – ISO	64
FD72 Series – Push to Connect – Connect Under Pressure	66
FD76 Series – Male Tip – ISO	68
<b>Special Application</b>	
FD14 Series – Drain Coupling	23
FD15 Series – Oil Sampling Valve	25
FD69 Series – High Pressure/Water Blast	62
FD90 Series – Diagnostic	76
<b>Configuration Index</b>	6
<b>Coupling Construction</b>	9
<b>Coupling Selection Chart</b>	13
<b>Fluid Compatibility Chart</b>	15
<b>How to Order</b>	7
<b>Part Number Index</b>	3
<b>Industry Application Symbols</b>	5
<b>Safety Information</b>	8



Part numbers listed below are base part numbers that exclude size designation, for complete part number refer to page referenced.

Part Number	Page	Part Number	Page	Part Number	Page
150-22	51	FD14	23	FD45-1061	34
487	56	FD14-1001	24	FD45-1062	41
5100	49	FD14-1002	24	FD45-1063	34
5100	51	FD14-1004	24	FD45-1064	34
5100-22	51	FD14-1204	24	FD45-1065	34
5100-S2	50	FD14-1206	24	FD45-1070	34
5100-S4	50	FD14-1210	24	FD45-1071	34
5100-S5	50	FD14-4002	24	FD45-1072	34
5100-S7	51	FD14-4003	24	FD45-1075	41
5100-S9	51	FD15	25	FD45-1076	41
5101	50	FD15-1000	26	FD45-1078	41
5110	51	FD15-1002	26	FD45-1086	38
5110-S5	50	FD15-1025	26	FD45-1090	38
5111	51	FD15-1026	26	FD45-1091	38
5400	52	FD35	27	FD45-1092	38
5400-17	56	FD35-1000	28	FD45-1100	38
5400-53	56	FD35-1001	28	FD45-1101	38
5400-54	56	FD35-1002	28	FD45-1120	41
5400-S2	54	FD35-1006	29	FD45-1121	41
5400-S5	54	FD35-1007	28	FD45-1122	41
5400-S6	54	FD35-1008	28	FD45-1142	41
5400-S8	54	FD35-1042	29	FD45-1143	42
5400-S16	56	FD35-1043	29	FD45-1153	38
5400-S19	56	FD35-1044	29	FD45-1156	38
5400-S20	56	FD40	17	FD45-1157	38
5401-S14	56	FD40-1000	18	FD45-1168	35
5401-S17	53	FD40-1001	18	FD45-1169	35
5410	53	FD40-1013	18	FD45-1172	34
5410-S14	53	FD40-1013	22	FD45-1173	35
5410-S17	53	FD40-1014	18	FD45-1174	39
5600	57	FD40-1014	22	FD45-1175	38
5600	58	FD41	19	FD45-1176	38
5601	58	FD41-1000	20	FD45-1177	39
5602	58	FD41-1013	20	FD45-1178	38
5603	61	FD41-1014	20	FD45-1179	39
5606	60	FD42	30	FD45-1180	38
5608	60	FD42-1000	31	FD45-1194	42
5610	60	FD42-1001	31	FD45-1195	41
5642	58	FD42-1002	31	FD45-1197	42
5643	58	FD42-1006	31	FD45-1199	39
5644	58	FD42-1008	31	FD45-1201	39
5650	59	FD42-1010	31	FD45-1203	39
5651	59	FD43	21	FD45-1206	35
5657	61	FD43-1001	22	FD45-1207	34
5657	61	FD43-1011	22	FD45-1209	42
5657	65	FD43-1031	22	FD45-1211	39
5659	61	FD45 Steel	33	FD45-1228	45
5659	61	FD45 Brass	37	FD45-1229	45
5659	65	FD45 Stainless Steel	40	FD45-1237	35
5667	61	FD45-1000	34	FD45-1238	35
5668	61	FD45-1001	41	FD45-1267	43
5690	61	FD45-1002	34	FD45-1270	43
5691	60	FD45-1002	34	FD45-1399	38
22008	56	FD45-1003	34	FD45-1400	38
22546	54	FD45-1004	41	FD45-1411	43
22546	54	FD45-1005	41	FD45-1414	35
22546	54	FD45-1040	36	FD45-1415	35
22546	56	FD45-1041	36	FD45-1417	43
202208	54	FD45-1044	35	FD48	44
202208	56	FD45-1045	35	FD48-1000	45
202220	54	FD45-1046	35	FD48-1001	45
560078	60	FD45-1047	34	FD48-1002	45
565006	59	FD45-1052	42	FD48-1042	45
565007	59	FD45-1053	41	FD49	46
565014	61	FD45-1056	42	FD49-1001	47
565015	61	FD45-1059	42	FD49-1002	47



Part numbers listed below are base part numbers that exclude size designation, for complete part number refer to page referenced.

Part Number	Page	Part Number	Page
FD49-1004	47	FD86-1035	71
FD49-1005	47	FD86-1039	71
FD49-1014	48	FD86-1040	71
FD49-1042	48	FD86-1041	71
FD49-1057	47	FD86-1042	70
FD49-1088	48	FD86-1043	70
FD49-1200	48	FD86-1044	70
FD56-1009	60	FD86-1049	71
FD56-1012	60	FD86-1050	71
FD56-1037	58	FD86-1051	71
FD56-1062	58	FD86-1052	70
FD56-1064	58	FD86-1053	70
FD56-1065	58	FD86-1054	70
FD56-1070	59	FD89	72
FD56-1071	59	FD89-1001	74
FD56-1072	60	FD89-1002	74
FD56-1074	60	FD89-1004	75
FD56-1075	60	FD89-1005	75
FD56-1081	61	FD89-1006	74
FD56-1082	61	FD89-1007	74
FD56-1123	59	FD89-1008	76
FD56-1125	59	FD89-1009	76
FD56-1196	59	FD90	76
FD56-1201	59	FD90-1004	77
FD56-1204	58	FD90-1012	77
FD56-1205	59	FD90-1021	77
FD56-1207	58	FD90-1034	77
FD56-1208	59	FD90-1035	77
FD56-1209	60	FD90-1040	77
FD56-1210	61	FD90-1041	77
FD56-1221	60	FD90-1044	77
FD56-1225	58	FD90-1045	77
FD56-1226	59	FD90-1046	77
FD56-1233	60	FD90-1061	78
FD56-1234	61	FD90-1090	78
FD56-1239	59	FD90-1206	78
FD56-1270	61	FD90-1047	77
FD69	62	FF013	35
FD69-1000	63	FF014	35
FD69-1001	63	FF015	35
FD69-1002	63	FF016	38
FD69-1010	63	FF017	38
FD69-1011	63	FF018	38
FD69-1012	63	FF054	41
FD69-1026	63	FF055	41
FD69-1027	63	FF056	41
FD69-1028	63	FF082	58
FD69-1029	63	FF092	58
FD70	68	FF093	58
FD70-1010	68	FF098	50
FD71	64	FF1607	32
FD71-1001	65	FF10166	64
FD72	66	FF10173	29
FD72-1001	67	FF10174	29
FD76	68	FF10175	29
FD76-1002	68	FF10593	71
FD76-1010	68	FF10594	71
FD86	69	FF10595	71
FD86-1001	71	FF10596	71
FD86-1002	71	FF10597	71
FD86-1004	71	FF10598	71
FD86-1006	70		
FD86-1008	70		
FD86-1010	70		
FD86-1016	71		
FD86-1018	71		



## Industry Application Symbols

Industry symbols are provided for each coupling indicating where it is typically used. But remember, a coupling can be used in any industry, provided it meets the established application requirements.

### Marine and Defense



FD14, FD15, FD35, FD45 (stainless), FD45 (brass), 5100, 5400, 5600, FD69, FD86, FD90

### Agriculture

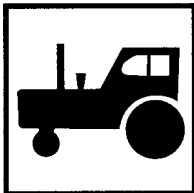

FD14, FD42, FD48, 5400, 5600, FD70, FD71, FD72, FD76, FD90

### Electronic Cooling

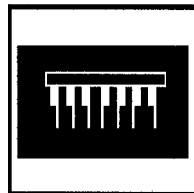

FD45 (stainless), FD45 (brass), 5100, 5400

### Pharmaceutical/Medical

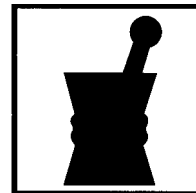

FD15, FD45 (brass), FD45 (stainless), 5400

### Chemical Processing



FD45, FD49, 5100, 5400

### Food & Beverage

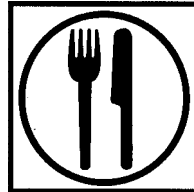

FD15, FD45 (stainless)

### Industrial Plants

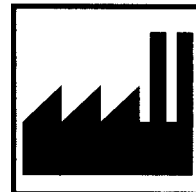

FD14, FD35, FD40, FD41, FD43, FD45 (steel), FD45 (brass), FD45 (stainless), FD48, FD49, 5100, 5600, FD69, FD86, FD89, FD90

### Construction



FD14, FD15, FD35, FD40, FD41, FD42, FD43, FD45 (steel), FD48, FD49, 5100, 5400, 5600, FD69, FD86, FD89, FD90

### Forestry

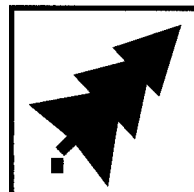

FD14, FD15, 5600, FD86, FD89

### Transportation

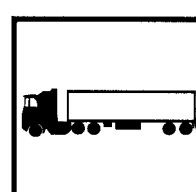

FD14, FD15, FD42, FD45 (steel), FD45 (brass), 5100, 5400, 5600, FD90

### Oil and Gas

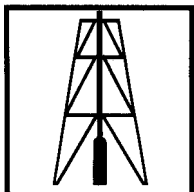

FD15, FD35, FD45 (stainless), FD45 (brass), 5100, 5600, FD86, FD90

### Maintenance & Repair Operations



FD14, FD40, FD41, FD43, FD45 (steel), FD45 (brass), FD49, 5100, 5600, FD69, FD90

### Utility

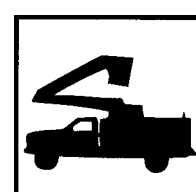

FD14, FD15, FD35, FD45 (steel), FD49, 5100, 5600, FD86, FD89, FD90



**AIR COUPLINGS**

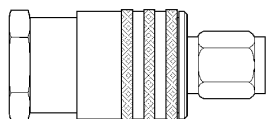

**FD40 Series – page 17**  
MIL-C-4109 Interchange—  
Automatic Sleeve

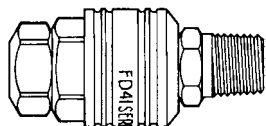

**FD41 Series – page 19**  
ARO-210 Interchange

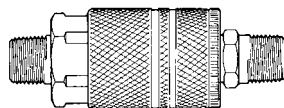

**FD43 Series – page 21**  
MIL-C-4109 Interchange—  
Manual Sleeve

**HYDRAULIC—FARM**

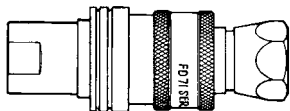

**FD71 Series – page 64**  
Push to Connect  
ISO Interchange

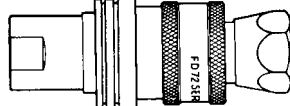

**FD72 Series – page 66**  
Push to Connect  
Connect Under Pressure—Male  
ISO Interchange

**Male Tips**

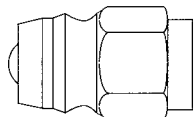

**FD70 Series – page 68**  
Deere Interchange

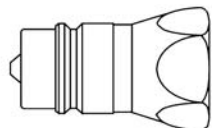

**FD76 Series – page 68**  
ISO Standard

**FLUID TRANSFER and HYDRAULIC**

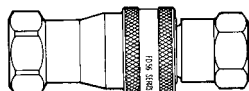

**5600 Series – page 57**  
General Purpose Industrial Interchange  
ISO 7241/1 Series A

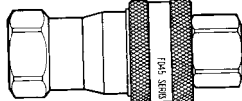

**FD45 Series**  
Steel...page 33  
Brass...page 37  
Stainless Steel...page 40  
Industrial Interchange  
ISO 7241/1 Series B

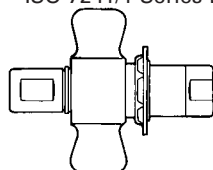

**5100 Series – page 49**  
Thread Together—Low Spill

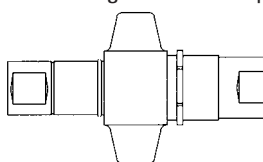

**FD86 Series – page 69**  
5000 psi High Impulse—DryBreak



**FD49 Series – page 46**  
Flush Face—No Spill  
HTMA Interchange

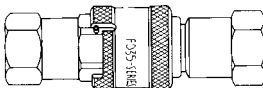

**FD35 Series – page 27**  
High Pressure—“Arc Latch”™



**FD42 Series – page 30**  
Pioneer 4000-2 Interchange

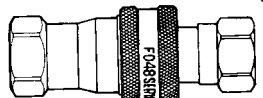

**FD48 Series – page 44**  
Bruning SM-250 Interchange

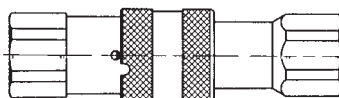

**FD89 Series – page 72**  
ISO 16028 Interchange

**FLUID TRANSFER and REFRIGERANT**

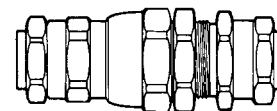

**5400 Series – page 52**  
Low Spill—Low Air Inclusion

**SPECIAL APPLICATION**

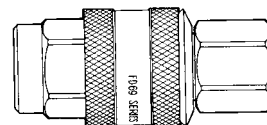

**FD69 Series – page 62**  
Water Blast “Arc Latch”™

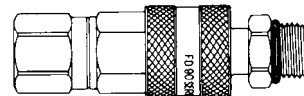

**FD90 Series – page 76**  
Diagnostic SAE J1502 Interchange

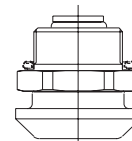

**FD14 Series – page 23**  
Drain Coupling

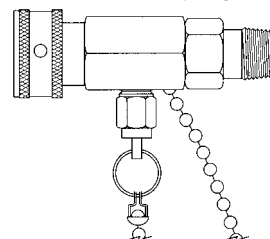

**FD15 Series – page 25**  
Oil Sampling Valve



**How to Order**

Eaton quick disconnect couplings can generally be ordered as a complete assembly or as separate halves. Couplings ordered by complete assembly part numbers will be supplied by halves. For special packaging, contact Eaton. (The FD14, FD40, FD41, FD43, FD86, FD89 and FD90 series are ordered by halves only.)

Standard coupling part numbers are described below:

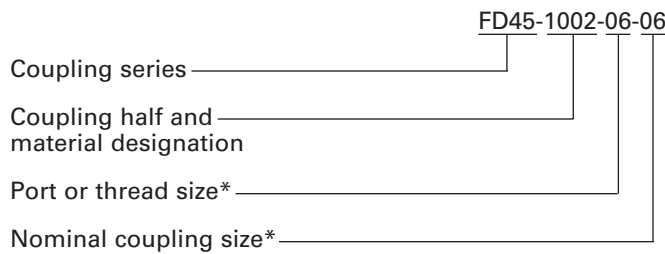
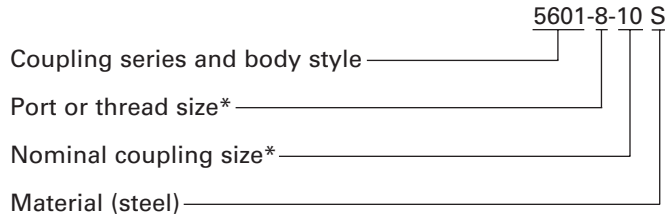

\*Size designations are represented in 16ths of an inch, i.e., 06 = 6/16 or 3/8 inch

**Dimensions**

Dimensions in this catalog are for reference only. Actual dimensions may vary from those shown.

**Coupling Identification**

Generally, the coupling series or complete part number will be stenciled on the coupling body.

**Caution:**

The user should observe carefully the precautions listed in this catalog. These include selection of seals and body materials for fluid compatibility and recommendations on the selection of quick disconnect couplings. In addition, care should be taken not to exceed the maximum operating pressures listed for each coupling size and type shown in the physical characteristics table for each coupling. Because of possible variations in machining tolerances, quality control, inspection and quality assurance, Eaton coupling halves should not be used with coupling halves supplied by other manufacturers except where such use is approved for a particular coupling as noted in this catalog.

**For Technical Assistance Contact:**

Eaton, Hydraulics  
 14615 Lone Oak Road  
 Eden Prairie, MN 55344  
**Phone: 952 937-9800, FAX: 952 974-7722**



Construction



Electronic Cooling



Forestry





## Safety Information for Eaton Coupling and Swivel Products

### 1.0 General Instructions

**1.1 Scope.** The scope of this safety bulletin is to warn against improper selection, use, installation, etc. of Eaton coupling/swivel products.

**1.2 Distribution.** A copy of this safety bulletin should be distributed to all individuals responsible for using and/or selecting Eaton coupling/swivel products.

**1.3 Fail-Safe.** Design all systems and equipment for fail-safe operation such that failure of any component does not result in personal injury and/or property damage.

**1.4 User Responsibility.** It is the sole responsibility of the user to select and determine that the Eaton product is compatible with the end use application. The user is responsible for reading and following this safety bulletin as well as any instructions or literature on the Eaton product being used. The user must provide necessary product warnings for Eaton couplings/swivel products, used with systems or equipment, to the operators of the systems or equipment.

**1.5 Usage with other Manufacturers' Products.** When using Eaton coupling/swivel products with other manufacturers' adapters, hoses, etc., do not exceed the lowest pressure rating of any of the components being used or rupture may result.

### 2.0 Selection of Eaton Couplings/Swivels.

**2.1 Pressure.** Ensure that the maximum operating pressure of the system or equipment does not exceed the rated operating pressure of the Eaton coupling/swivel product or rupture may result.

**2.2 Fluid compatibility.** Verify that all components (seals, metals, etc.) are compatible with the fluid being conveyed. Failure to do so may result in high speed fluid discharge and/or leakage of fluids which may be flammable, toxic, at extreme temperatures, or otherwise harmful.

**2.3 Temperature.** Ensure that the maximum operating temperature of the system or equipment does not exceed the rated operating temperature of the Eaton coupling/swivel product (including seals) or rupture may result.

**2.4 Coupling/Swivel Size.** Use properly sized couplings/swivels such that there is not a large pressure drop across them thus avoiding system damage due to excessive heat generation or failure of internal components.

**2.5 Sleeve Lock.** Use sleeve locks or threaded couplings where there is the possibility of accidental disconnection. Failure to utilize sleeve locks or threaded couplings in these applications may result in hose whip, expelled components, high speed fluid discharge, system damage, or leakage of fluids which may be flammable, toxic, at extreme temperatures, or otherwise harmful.

**2.6 Connect or Disconnect Under Pressure.** If connection and/or disconnection of couplings under pressure is a requirement, only use couplings designed for connection/disconnection under pressure. Failure to utilize this type of coupling in that application may result in hose whip, expelled components, high speed fluid discharge, and/or system damage. Be certain not to confuse the rated operating pressure with the rated connect/disconnect under pressure.

**2.7 Environment.** Ensure that Eaton couplings/swivels are compatible with the surrounding environment. The surrounding environment may be heat, salt water, moisture, chemicals, and the like. Failure to protect against an adverse environment may cause system damage, premature failure, and/or leakage of fluids which may be flammable, toxic, at extreme temperatures, or otherwise harmful.

**2.8 External Loads.** Avoid any external loads such as side loads, tensile loads, vibration, etc. Failure to do so may result in accidental disconnection, premature failure, system damage, and/or leakage of fluids which may be flammable, toxic, at extreme temperatures, or otherwise harmful.

**2.9 Welding & Brazing.** Extreme heating of plated products above +450°F (+232°C) such as welding, brazing, baking, etc., where the plating is burned off, may result in the release of deadly gases.

### 3.0 Installation of Eaton Coupling & Swivel Products.

**3.1 Inspection of Product.** Prior to installation, ensure that the Eaton product meets all of the requirements of the system and/or equipment it is to be used on. Ensure you have the correct part number, function test the coupling by connecting it with a mating half, and function test the swivel by rotating the sleeve. The function test should result in smooth, non-binding operation or premature failure may result.

**3.2 Cleanliness.** Use end caps and plugs to reduce the risk of system contamination or damage to critical sealing surfaces. Failure to do so may result in leakage of fluids which may be flammable, toxic, at extreme temperatures, or otherwise harmful. Caps and plugs are not a secondary seal unless explicitly noted.

**3.3 Location.** Place Eaton couplings and swivels in a safe location such as not to expose the user to personal injury (slippage, tripping, falling, etc.) during installation, connection, disconnection and maintenance.

**4.0 Product Maintenance.** A maintenance schedule should be put in place to ensure that Eaton couplings and swivels are functioning properly.

**4.1 Inspection.** Visually inspect to ensure that there is NO leakage, cracked components, corrosion build-up, contamination build-up, wear, etc. If any abnormality is encountered, the coupling or swivel should be replaced immediately.



## Quick Disconnect Couplings

Quick disconnect couplings are connecting devices which permit easy, immediate connection and separation of fluid lines. When installed in a fluid system, quick disconnect couplings save time by eliminating system bleeding, recharging and purging of air whenever an accessory is being replaced. Dependability is assured because the coupling valves automatically open and close and because the possibility of air, dirt, and moisture being trapped in the system is minimized.

Eaton quick disconnect couplings may be used in systems to help align components and the swivel feature helps prevent twisting of hose assemblies. However, they are not intended to be used as swivel joints in applications subjected to constant rotation. Eaton swivel joints should be used in these applications. See document E-MESW-MC001-E.

## Selection of Quick Disconnect Couplings

See selection chart on pages 13 and 14.

The following questions should be answered before selecting or specifying a quick disconnect coupling.

1. What are the functional requirements of the coupling?
2. To what pressures will the coupling be subjected?
3. What are the flow requirements of the coupling?
4. What is the maximum acceptable pressure drop at specified flow rate?
5. Is the coupling to be connected or disconnected under pressure? How much pressure? Which half?
6. What metals are compatible with the fluid in the system?
7. What seals are compatible with the system's fluid?
8. Are minimum air inclusion or fluid loss upon connection and disconnection critical to the proper operation of the system?
9. What threads and end configurations are necessary?
10. Is bulkhead flange or frame mounting necessary?
11. Should the coupling be interchangeable with other couplings presently in use?

## I. Types of Valves

### Double Poppet Valves – Most Common

FD14, FD35, FD42, FD45, FD48, 5600, FD71, FD72, FD76

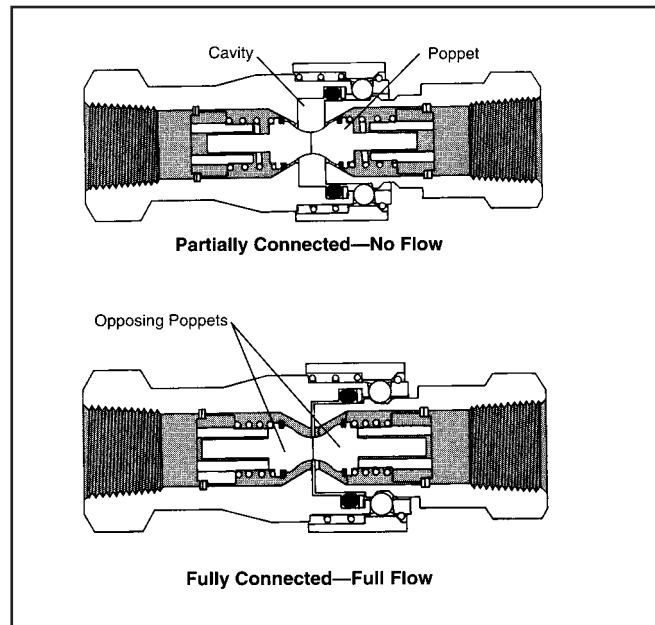

- Spring loaded poppet valves in each half immediately self-seal both halves upon disconnection.
- Cavity between halves allows some air inclusion when connecting and some fluid loss upon disconnection.
- Durable and economical.



**Valved – One Side**  
FD40, FD41, FD43, FD45, 5600

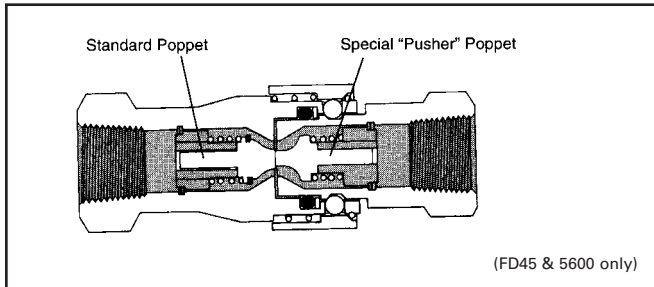

- Immediate self-sealing in valved half only.
- Either male or female half can be valved.
- Full flow in non-valved half upon disconnection.

*NOTE: A "Pusher" poppet is needed in non-valved half to open poppet in valved half except for FD40, FD41 and FD43.*

**No Valves**  
FD45, 5600, FD69

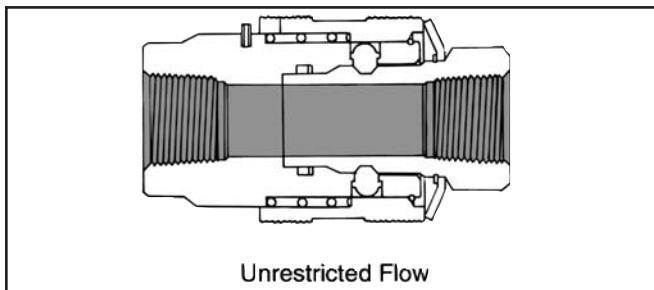

- Full flow when connected and disconnected.
- Minimum pressure drop.
- Maximum flow.

**Tubular Valve and Sleeve – Poppet**  
FD49, 5100, 5400, FD86, FD89, FD90

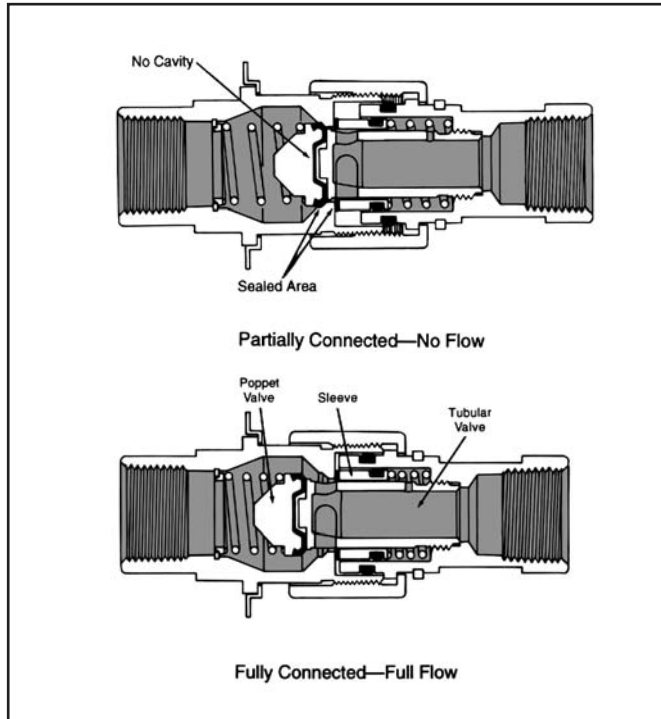

- Precision valving for low air inclusion and fluid loss.
- Spring loaded sleeve provides access to tubular valve ports.
- Poppet valve in opposing half self seals.
- No cavity between halves to cause spillage or air inclusion.

**Ball Bearing Valve**  
FD70

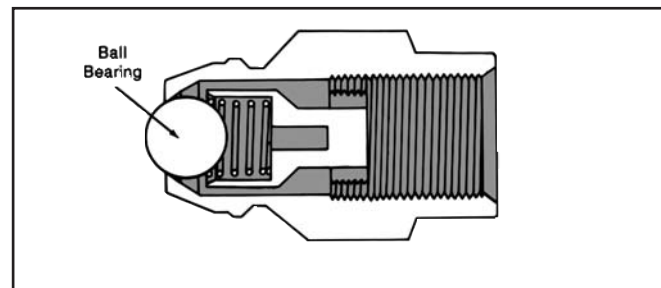

- Spring loaded ball bearing.
- Durable and economical.
- Not recommended for vacuum.
- Metal-to-metal seal.



## II. Types of Latches

### Threaded Connections 5100, 5400, FD86

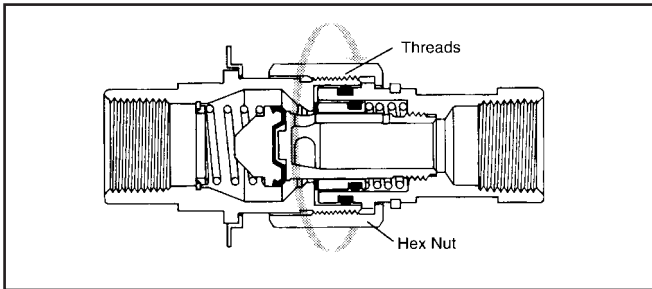

- Uses mechanical advantage of threads to connect or disconnect under pressure.
- Greater holding power under impulsing and vibration.
- Union nuts may be wing or hex type.

### Ball Latch Connections FD14, FD40, FD42, FD43, FD45, FD48, FD49, 5600 (FD56), FD71, FD72, FD89, FD90

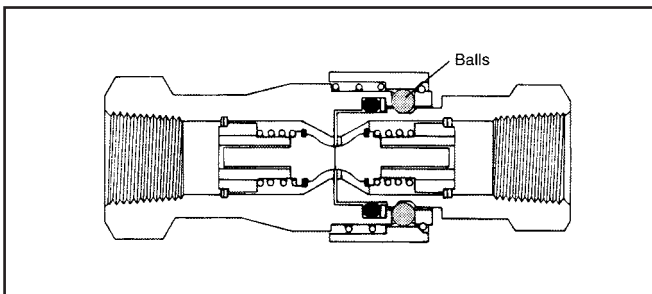

- Series of balls on female half, lock into recess on male half.
- Allows for 360° swiveling (not intended for constant swiveling).
- Quick and easy to connect and disconnect.
- Can be used as an emergency breakaway when female sleeve is frame mounted.
- Most popular and economical latching design.

### "Arc Latch"™ Connections FD35, FD69

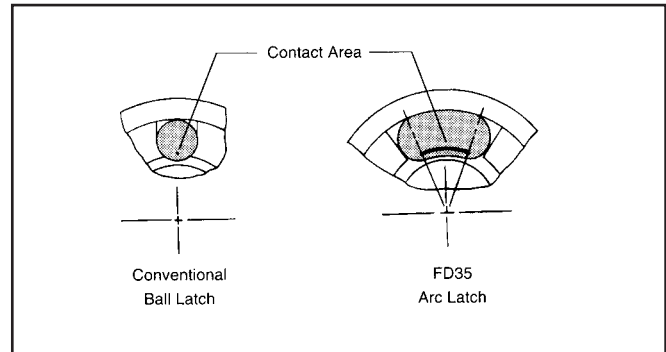

- Exclusive Eaton design.
- Series of arcs in female half, lock into recess on male half (same as ball latch).
- Greater surface contact area gives tremendous holding strength.
- For high pressure applications.

### Bar/Pin Latch Connections FD41

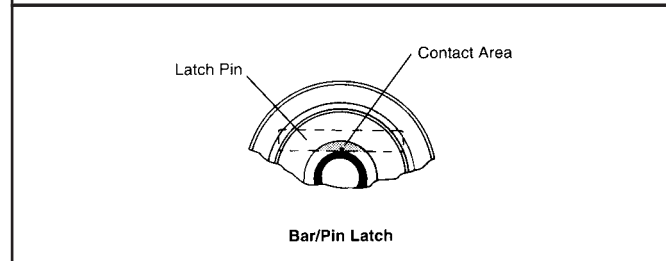
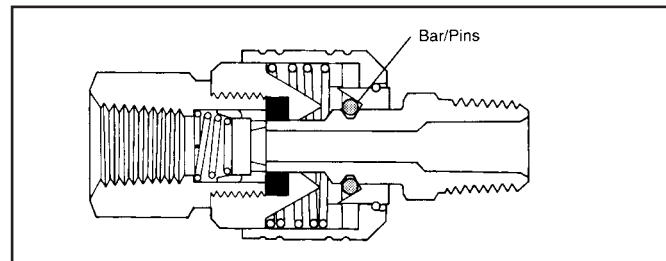

- Two bar/pins in female half lock into recess on male half.
- Allows for 360° swiveling (not intended for constant swiveling).
- Design allows for push to connect operation.
- Typically used for low pressure applications.



### Latching Methods—(How To) Push-to-Connect

FD14, FD40, FD41, FD49, FD89, FD90,  
(FD71, FD72 when female half is frame mounted)

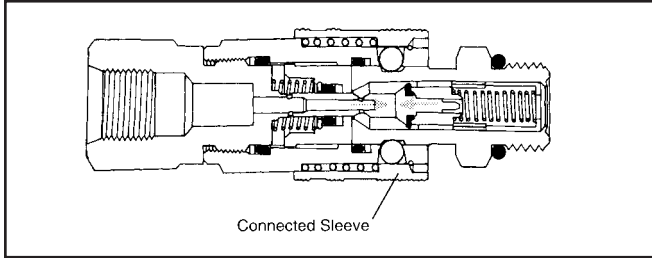

#### To Connect

- Relieve system pressure.
- Insert and push male half into female half.
- Release sleeve on female half will connect automatically.
- Only one hand is required.
- FD71, FD72, only—to obtain push-to-connect female half must be frame mounted. (Ref. 5603 breakaway frame.) Female half end port must be connected to a 12" minimum length of flexible hose for full female body motion.

#### To Disconnect

- Relieve system pressure.
- Manually retract release sleeve on female half and remove male half.
- FD71, FD72 only—female half must be frame mounted and will automatically disconnect when male half is pulled out. This requires a slightly higher force to disconnect.

### Retract (Sleeve) To-Connect

FD35, FD42, FD43, FD45, FD48, 5600 (FD56), FD69

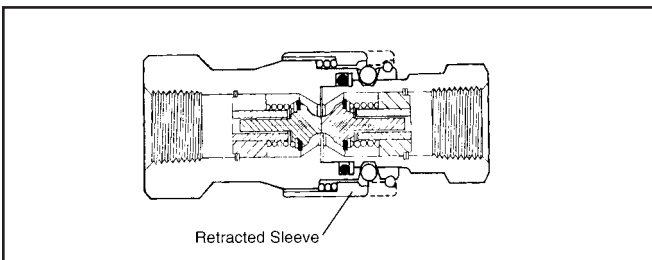

#### To Connect

- Relieve system pressure.
- Pull back and hold release sleeve on female half.
- Insert male half.
- Let go of release sleeve on female half.

#### To Disconnect

- Relieve system pressure.
- Pull back and hold release sleeve on female half.
- Remove male half.
- Let go of release sleeve on female half.

### Thread-to-Connect

5100, 5400, FD86

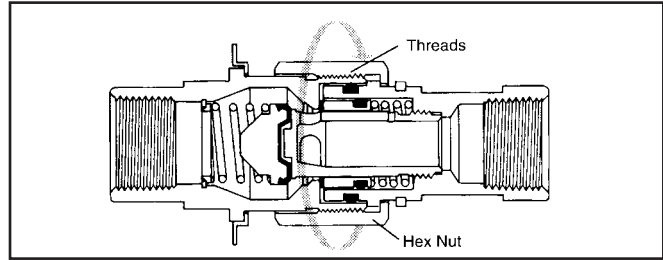

- Prevent male from rotating.
- Insert male into union nut on female body assembly.
- Rotate union nut clockwise.
  - With hand if wing nut type.
  - With wrench if hex nut type.
- Tighten as follows.

#### 5100 Series

- Tighten until halves bottom out and connection indicator *groove* is no longer visible.

#### FD86 Series

- Tighten until halves bottom out and connection indicator *O-Ring* is no longer visible.

#### 5400 Series

- Recommended torque values for S2 half to S5 half are listed below.

Dash Size	Torque – ft. lbs.
–4	10–12
–8	35–37
–12	45–47
–16	65–67

# COUPLING SELECTION CHART



Below is a capability selection chart to aid you in locating the proper coupling to meet your requirements. This chart should be used in conjunction with the fluid compatibility charts on pages 15 and 16 and the appropriate product pages.

This information is intended as a guide only and final selection is further dependent on fluid and ambient temperature, concentration of agent, intermittent or continuous exposure, etc.

For further details on a specific coupling, see the appropriate catalog pages.

Where dash sizes appear in the chart below, the coupling is available only in those sizes.

The check marks (✓) in the chart below indicate product is normally available in either final assembly and/or component form. Contact Eaton for availability of products without a check mark.

Function	Nominal Coupling Size (inches)	Dash Size	FD14 Pg. 23	FD15 Pg. 25	FD35 Pg. 27	FD40 Pg. 17	FD41 Pg. 19	FD42 Pg. 30	FD43 Pg. 21	FD45			FD48 Pg. 45
										Steel Pg. 33	Brass Pg. 37	SS Pg. 40	
Maximum Operating Pressure (psi connected)	1/8	-2								4500	1000		
	1/4	-4		50/300		300	300	3000	300	5000	1000	3000	3000
	3/8	-6	50		10000	300			300	4000	1000	1500	
	1/2	-8				300			300				
	1/2	-8-10								4000	1000	1500	
	3/4	-12								4000	1000	1500	
	1	-16								4000	1000	1250	
	1 1/4	-20									1000		
1 1/2	-24												
2	-32												
Vacuum (in./Hg.)			28	28	28	28	28	28		28	28	28	28
Choice of Seals (other seal compounds available upon request)	Buna-N		✓	✓		✓	✓	✓		✓	✓	✓	✓
	Neoprene								✓				
	EPR									✓	✓	✓	
	Viton		✓		✓					✓	✓	✓	
Valve Options	No-spill valving			N/A									
	Double valve		✓	N/A	✓			✓		✓	✓	✓	✓
	Valved male only			N/A						✓	✓	✓	
	Valved female only			N/A		✓	✓		✓	✓	✓	✓	
	Straight thru - no valves			N/A						✓	✓	✓	
Basic Material	Steel		✓	✓	✓	✓	✓	✓	✓	✓			✓
	Brass										✓		
	Stainless Steel											✓	
	Aluminum												
	Polypropylene												
Latch Style	"Arc latch" <sup>TM</sup>				✓								
	Ball latch		✓			✓		✓	✓	✓	✓	✓	✓
	Bar Pin latch						✓						
	Threaded												
End Connections	Female pipe		✓		✓	✓	✓	✓	✓	✓	✓	✓	✓
	Male pipe		✓	✓		✓	✓		✓				
	Fem. st. thd. O-ring				✓			✓					
	Male st. thd. O-ring		✓	✓									
	SAE 37° (JIC) male												
	Metric male O-ring		✓										
	Braze												
	Hose barb								✓				
Female BSP													
Mounting Method	Bulkhead							✓					
	Flange												
	Frame												
Connect Under Pressure					✓	✓		✓					
Caps/Plugs		✓		✓			✓		✓	✓	✓	✓	
Full Field Service				✓					✓	✓	✓		
Push to Connect (Automatic Sleeve)		✓			✓	✓							
Interchangeable with Other Brands				✓	✓	✓	✓	✓	✓	✓	✓	✓	



Function	Nominal Coupling Size (inches)	Dash Size	FD49 Pg. 46	5100 Pg. 49	5400 Pg. 52	5600 Pg. 57	FD69 Pg. 62	FD71 Pg. 64	FD72 Pg. 66	FD86 Pg. 69	FD89 PG. 72	FD90 Pg. 76
<b>Maximum Operating Pressure (psi connected)</b>	1/8	-2										
	1/4	-4		3000*	3000*	5000					4350	7000
	3/8	-6	3000	3000*		4000					4350	
	1/2	-8		3000*	1750*		10000				3625	
	1/2	-8-10				4000		3000	3000		3625	
	3/4	-12		3000*	700*	4000					3625	
	1	-16		3000*	700*	4000				5000	3625	
	1 1/4	-20			2750*					5000	3625	
	1 1/2	-24			2500*						2900	
2	-32									2900		
<b>Vacuum (in./Hg.)</b>			28	28	28	28	28	28	28	28	28	28
<b>Choice of Seals (other seal compounds available upon request)</b>	Buna-N		✓	✓		✓	✓	✓	✓	✓	✓	✓
	Neoprene				✓							
	EPR			✓		✓	✓			✓		✓
	Viton			✓		✓	✓			✓		✓
<b>Valve Options</b>	No spill valving		✓	✓	✓	✓	✓	✓				
	Double valve		✓	✓	✓	✓		✓	✓	✓	✓	✓
	Valved male only					✓						
	Valved female only					✓						
	Straight thru – no valves					✓	✓					
<b>Basic Material</b>	Steel		✓		✓	✓	✓	✓	✓	✓	✓	✓
	Brass			✓								
	Stainless Steel						✓					
	Aluminum											
	Polypropylene											
<b>Latch Style</b>	"Arc latch™"						✓					
	Ball latch		✓			✓		✓	✓		✓	✓
	Bar Pin latch											
	Threaded			✓	✓					✓		
<b>End Connections</b>	Female pipe		✓	✓		✓	✓	✓	✓	✓	✓	✓
	Male pipe											✓
	Fem. st. thd. O-ring		✓			✓				✓	✓	✓
	Male st. thd. O-ring		✓									✓
	SAE 37° (JIC) male				✓							✓
	Metric male O-ring											✓
	Braze				✓							
	Hose barb											
Female BSP					✓					✓		
<b>Mounting Method</b>	Bulkhead				✓			✓	✓			✓
	Flange			✓						✓		
	Frame					✓		✓	✓			
<b>Connect Under Pressure</b>			500	500	✓	-8 -10			✓	750		500
<b>Caps/Plugs</b>			✓	✓	✓	✓		✓	✓	✓	✓	✓
<b>Full Field Service</b>			✓	✓	✓	✓	✓		✓			
<b>Push to Connect (Automatic Sleeve)</b>			✓					✓	✓		✓	✓
<b>Interchangeable with Other Brands</b>			✓	✓	✓	✓		✓	✓		✓	✓

\*Not recommended for continuous hydraulic impulse applications at maximum operating pressure.



**FLUID COMPATIBILITY**

This chart indicates the suitability of various elastomers and metals for use with fluids to be conveyed. It is intended for use with Eaton couplings and should not be used to determine compatibility for other products. It is intended as a guide only and is not a guarantee. Final selection of the proper seal or material of metal components is further dependent on many factors including pressure, fluid and ambient temperature, concentration, duration of exposure, etc.

**HOW TO USE THE CHART**

- Both the elastomer and the metal must be considered when determining suitability of a combination for a coupling.
- Locate the fluid to be conveyed and determine the suitability of the elastomeric and metal components according to the resistance ratings shown for each.
- Dimensional and operation specifications for each coupling can be found on the catalog pages.
- Information on seal options for couplings, and how to specify them, are shown in the respective sections of this catalog.
- Be sure to check the table below for maximum operating temperature range of the elastomer for desired temperature.
- For further details on the products shown in this catalog, and their applications, consult your Eaton Sales Representative or Eaton Technical Support.
- Coupling component materials may differ from body material. Refer to specific catalog pages.

**RESISTANCE RATING KEY**

E=Excellent – Fluid has little or no effect.  
 G=Good – Fluid has minor to moderate effect.  
 C=Conditional – Service conditions should be described to Eaton for determination of suitability for application.  
 U=UNSATISFACTORY

The differences between ratings “E” and “G” are relative. Both indicate satisfactory service. Where there is a choice, the materials rated “E” may be expected to give better or longer service than those rated “G”.

**SEAL ELASTOMER DATA**

Seal Elastomer	Application Specification	Max. Operating Temperature Range
Buna-N	none	-40°F to +250°F (-40°C to +121°C)
Neoprene	none	-65°F to +300°F (-54°C to +149°C)
EPR (Ethylene Propylene Rubber)	none	-65°F to +300°F (-54°C to +149°C)
Viton	MIL-R-25897	-15°F to +400°F (-29°C to +204°C)

NOTE: This chart does not apply to bonded seals used in the 5100 and FD86 Series Couplings. Consult Eaton for special applications.

FLUID	SEALS				METAL				
	Buna-N	Neoprene	EPR/EPDM	Viton	Steel	Brass	Cres	Aluminum	Monel
E = EXCELLENT G = GOOD C = CONDITIONAL U = UNSATISFACTORY									
Acetaldehyde	E	E	E	U	E	U	E	E	E
Acetic Acid, 10%	U	U	C	U	U	U	U	U	U
Acetic Acid, Glacial	U	U	C	U	U	U	U	U	U
Acetone	U	U	C	U	U	U	U	U	U
Acetophenone	U	U	C	U	U	U	U	U	U
Acetyl Acetone	U	U	C	U	U	U	U	U	U
Acetyl Chloride	U	U	C	U	U	U	U	U	U
Acetylene	U	U	C	U	U	U	U	U	U
Air, Hot (Up to +160°F)	U	U	C	U	U	U	U	U	U
Air, Hot (161°F – 200°F)	U	U	C	U	U	U	U	U	U
Air, Hot (201°F – 300°F)	U	U	C	U	U	U	U	U	U
Air Wet	U	U	C	U	U	U	U	U	U
Aluminum Chloride	U	U	C	U	U	U	U	U	U
Aluminum Fluoride	U	U	C	U	U	U	U	U	U
Aluminum Nitrate	U	U	C	U	U	U	U	U	U
Aluminum Sulfate	U	U	C	U	U	U	U	U	U
Alums	U	U	C	U	U	U	U	U	U
Ammonia, Cold	U	U	C	U	U	U	U	U	U

FLUID	SEALS				METAL				
	Buna-N	Neoprene	EPR/EPDM	Viton	Steel	Brass	Cres	Aluminum	Monel
E = EXCELLENT G = GOOD C = CONDITIONAL U = UNSATISFACTORY									
Ammonia, Hot	U	G	G	U	E	U	E	E	E
Ammonia, Anhydrous	E	E	E	E	E	U	E	E	E
Ammonia, Aqueous	E	E	E	E	E	U	E	E	E
Ammonium Carbonate	E	E	E	E	E	U	E	E	E
Ammonium Chloride	E	E	E	E	E	U	E	E	E
Ammonium Hydroxide	E	E	E	E	E	U	E	E	E
Ammonium Nitrate	E	E	E	E	E	U	E	E	E
Ammonium Phosphate	E	E	E	E	E	U	E	E	E
Ammonium Sulfate/Sulfide	E	E	E	E	E	U	E	E	E
Amyl Acetate	U	U	U	U	U	U	U	U	U
Amyl Alcohol	U	U	U	U	U	U	U	U	U
Aniline, Aniline Oil	U	U	U	U	U	U	U	U	U
Aniline Dyes	U	U	U	U	U	U	U	U	U
Arsenic Acid	E	E	E	E	E	U	E	E	E
Asphalt	G	C	C	U	U	U	U	U	U
ASTM #1	E	E	E	E	E	U	E	E	E
ASTM #2	E	E	E	E	E	U	E	E	E
ASTM #3	E	E	E	E	E	U	E	E	E
Automatic Trans. Fluid	E	E	E	E	E	U	E	E	E
Barium Chloride	E	E	E	E	E	U	E	E	E
Barium Hydroxide	E	E	E	E	E	U	E	E	E
Barium Sulfide	E	E	E	E	E	U	E	E	E
Benzene, Benzol	U	U	U	U	U	U	U	U	U
Benzin	U	U	U	U	U	U	U	U	U
Benzoic Acid	U	U	U	U	U	U	U	U	U
Benzyl Alcohol	U	U	U	U	U	U	U	U	U
Black Sulfate Liquor	U	U	U	U	U	U	U	U	U
Blast Furnace Gas	U	U	U	U	U	U	U	U	U
Borax	G	G	G	G	G	G	G	G	G
Boric Acid	G	G	G	G	G	G	G	G	G
Bromine	U	U	U	U	U	U	U	U	U
Butane	U	U	U	U	U	U	U	U	U
Butyl Acetate	U	U	U	U	U	U	U	U	U
Butyl Alcohol	U	U	U	U	U	U	U	U	U
Butyl Cellosolve	U	U	U	U	U	U	U	U	U
Butylene	U	U	U	U	U	U	U	U	U
Butyl Stearate	U	U	U	U	U	U	U	U	U
Butyraldehyde	U	U	U	U	U	U	U	U	U
Calcium Acetate	E	E	E	E	E	U	E	E	E
Calcium Bisulfate	E	E	E	E	E	U	E	E	E
Calcium Chloride	E	E	E	E	E	U	E	E	E
Calcium Hydroxide	E	E	E	E	E	U	E	E	E
Calcium Hypochlorite	U	U	U	U	U	U	U	U	U
Calcium Nitrate	U	U	U	U	U	U	U	U	U
Cane Sugar Liquors	E	E	E	E	E	U	E	E	E
Carbitol	U	U	U	U	U	U	U	U	U
Carbolic Acid	U	U	U	U	U	U	U	U	U
Carbonic Acid	U	U	U	U	U	U	U	U	U
Carbon Dioxide	U	U	U	U	U	U	U	U	U
Carbon Disulfide	U	U	U	U	U	U	U	U	U
Carbon Monoxide	U	U	U	U	U	U	U	U	U
Carbon Tetrachloride	U	U	U	U	U	U	U	U	U
Castor Oil	U	U	U	U	U	U	U	U	U
Cellosolve Acetate	U	U	U	U	U	U	U	U	U
China Wood Oil (Tung Oil)	U	U	U	U	U	U	U	U	U
Chlorine	U	U	U	U	U	U	U	U	U
Chloracetic Acid	U	U	U	U	U	U	U	U	U
Chloroacetone	U	U	U	U	U	U	U	U	U
Chlorobenzene	U	U	U	U	U	U	U	U	U
Chloroform	U	U	U	U	U	U	U	U	U
Chlorophenol	U	U	U	U	U	U	U	U	U
Chlorosulfonic Acid	U	U	U	U	U	U	U	U	U
Chrome Plating Solution	U	U	U	U	U	U	U	U	U
Chromic Acid	U	U	U	U	U	U	U	U	U
Citric Acid	U	U	U	U	U	U	U	U	U
Coke Oven Gas	U	U	U	U	U	U	U	U	U
Copper Chloride	E	E	E	E	E	U	E	E	E
Copper Cyanide	E	E	E	E	E	U	E	E	E
Copper Sulfate	E	E	E	E	E	U	E	E	E
Cotton Seed Oil	U	U	U	U	U	U	U	U	U
Creosote (Coal Tar)	G	C	C	U	U	U	U	U	U
Crude Oil	G	C	C	U	U	U	U	U	U
Cyclohexanol	U	U	U	U	U	U	U	U	U
Cyclohexanone	U	U	U	U	U	U	U	U	U
Detergent/Water Solution	U	U	U	U	U	U	U	U	U
Diacetone Alcohol (Acetol)	U	U	U	U	U	U	U	U	U
Dibenzyl Ether	U	U	U	U	U	U	U	U	U
Diesel Oil	U	U	U	U	U	U	U	U	U
Diethylamine	U	U	U	U	U	U	U	U	U
Dowtherm A&E	U	U	U	U	U	U	U	U	U
Dowtherm 209	U	U	U	U	U	U	U	U	U
Ethyl Alcohol (Ethanol)	E	E	E	E	E	U	E	E	E
Ethyl Acetate	E	E	E	E	E	U	E	E	E
Ethyl Benzene	E	E	E	E	E	U	E	E	E
Ethyl Cellulose	E	E	E	E	E	U	E	E	E
Ethyl Chloride	E	E	E	E	E	U	E	E	E







## FD40 Series/MIL-C-4109 Industrial Interchange – Air

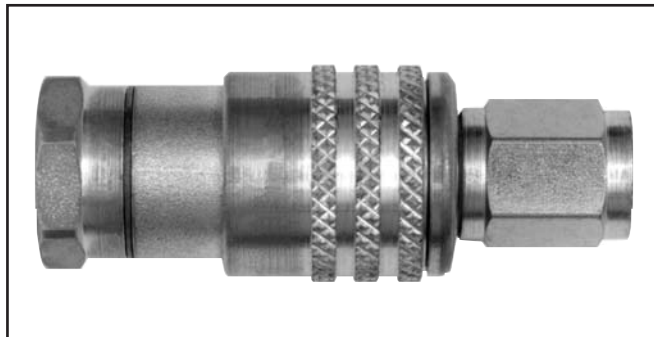
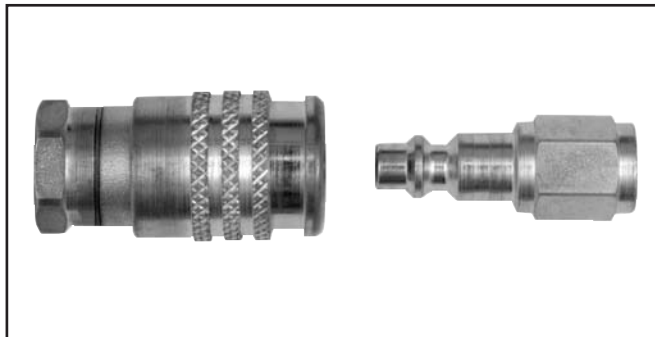

The FD40 Series offers a one-hand push-to-connect latch ideal for compressed air service. The female half features self-sealing poppet valves, preventing air loss while disconnected. Male half uses straight through design.

- Automatic sleeve for one-hand push-to-connect operation.
- Protective collar to prevent accidental snagging and disconnection.
- Meet dimensional requirements of MIL-C-4109 for industrial interchangeability.
- Swivels 360°, eliminating hose kinking.
- Ball latching mechanism.
- Standard seal material – Buna-N.
- Standard body material – Zinc plated steel.

### Flow Data

Pressure Drop Versus Flow Graph

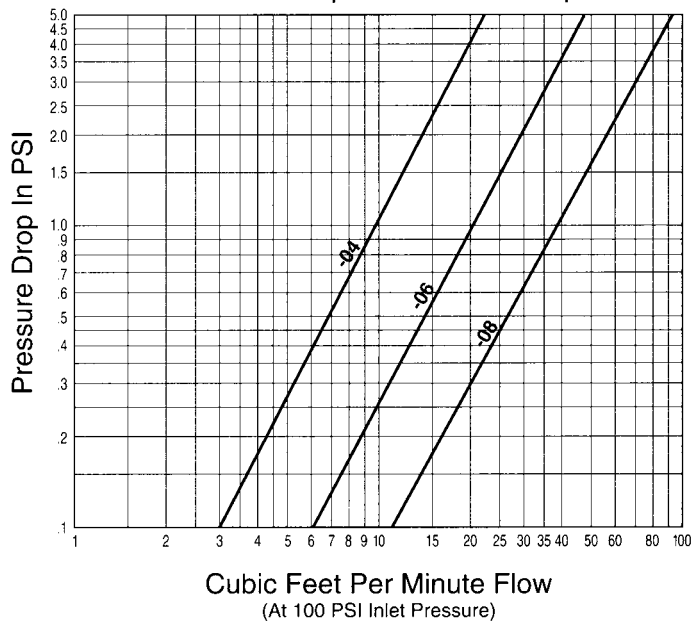

### Physical Characteristics

Coupling Size	Maximum Operating Pressure (psi)	Minimum Burst Pressure (psi)		Vacuum (in./Hg.) Connected Only
		Female Half Only	Connected	
-04	300	3000	8000	28
-06	300	3000	8000	28
-08	300	2000	8000	28



FD40 Series	Coupling Size	Thread Size(P)	Dimensional Data			Part Number Buna-N	Line Ref.
			A	B	$\phi Y$		
<b>Female Half Female Pipe/Valved</b> 	-04	1/4-18	1.88	1.00	.81	FD40-1000-04-04	2
	-04	3/8-18	2.56	1.00	.94	FD40-1000-06-04	3
	-06	1/4-18	2.63	1.16	.94	FD40-1000-04-06	4
	-06	3/8-18	2.13	1.16	.94	FD40-1000-06-06	5
	-08	1/2-14	2.38	1.28	1.06	FD40-1000-08-08	6
							7
							7
							8
<b>Female Half Male Pipe/Valved</b> 	-04	1/4-18	2.63	1.00	.81	FD40-1001-04-04	9
	-04	3/8-18	2.63	1.00	.81	FD40-1001-06-04	10
	-06	3/8-18	2.88	1.16	.94	FD40-1001-06-06	11
	-08	1/2-14	3.50	1.28	.88	FD40-1001-08-08	12
							13
							14
							15
							16
<b>Male Half Female Pipe/Non-Valved</b> 	-04	1/8-27	1.21		.56	FD40-1013-02-04	17
	-04	1/4-18	1.62		.62	FD40-1013-04-04	18
	-04	3/8-18	1.80		.88	FD40-1013-06-04	19
	-06	3/8-18	1.90		.88	FD40-1013-06-06	20
	-08	1/2-14	2.40		1.12	FD40-1013-08-08	21
							22
							23
							24
<b>Male Half Male Pipe/Non-Valved</b> 	-04	1/8-27	1.50		.50	FD40-1014-02-04	25
	-04	1/4-18	1.75		.56	FD40-1014-04-04	26
	-04	3/8-18	1.75		.69	FD40-1014-06-04	27
	-06	1/4-18	1.88		.62	FD40-1014-04-06	28
	-06	3/8-18	1.88		.69	FD40-1014-06-06	29
	-06	1/2-14	2.13		.88	FD40-1014-08-06	30
	-08	3/8-18	2.18		.69	FD40-1014-06-08	31
	-08	1/2-14	2.44		.88	FD40-1014-08-08	32



## FD41 Series/ARO 210 Interchange – Air

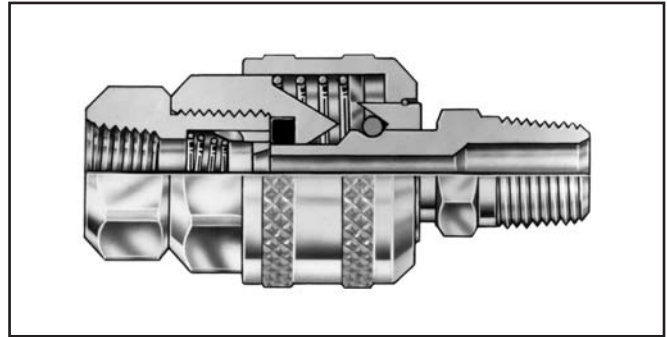
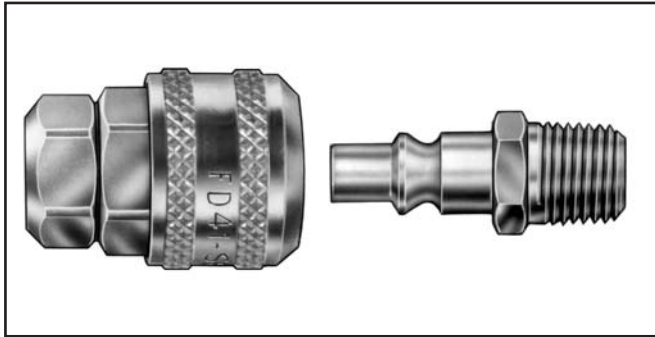

The FD41 interchanges with the ARO 210 Series for compressed air service, with a self-sealing female half and straight through male half.

- Designed to interchange with ARO 210 Series.
- Automatic sleeve for one hand push-to-connect operation.
- Swivels 360°, eliminating hose kinking.
- Designed to assure high flow with low pressure drop for peak tool performance.
- Standard seal material – Buna-N.
- Standard body material – Zinc plated steel.

### Flow Data

FD 41 SERIES  
PRESSURE DROP VERSUS FLOW GRAPH

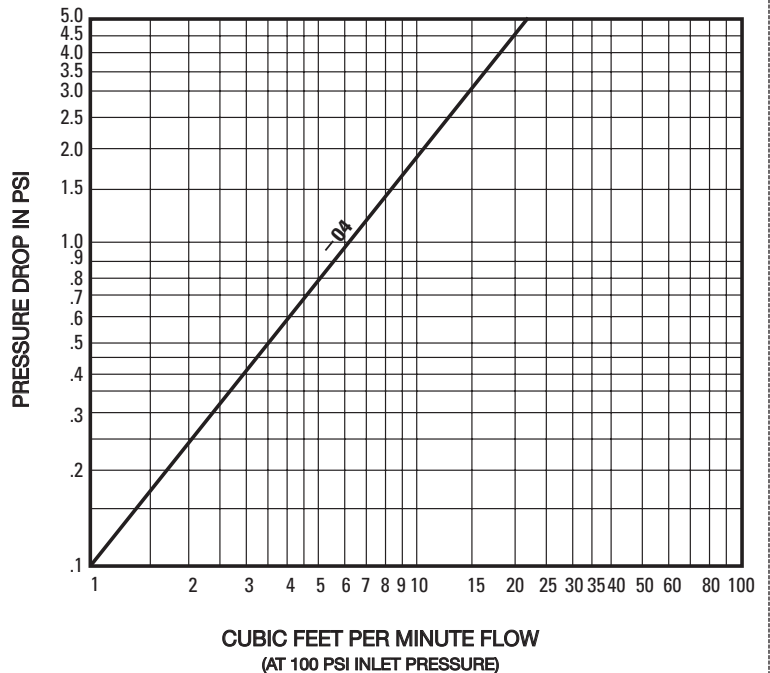

### Physical Characteristics

Coupling Size	Maximum Operating Pressure (psi)	Minimum Burst Pressure (psi)		Vacuum (in./Hg.) Connected Only
		Female Half Only	Connected	
-04	300	3000	8000	28



FD41 Series	Coupling Size	Thread Size (P)	Dimensional Data			Part Number Buna-N	Line Ref.
			A	B	$\phi$		
<p>Female Half Female Pipe/Valved</p>	-04	1/8-27	2.15	1.12	.62	FD41-1000-02-04	1
	-04	1/4-18	1.62	1.12	.81	FD41-1000-04-04	2
							3
							4
							5
							6
							7
							8
<p>Male Half Female Pipe/Non-Valved</p>	-04	1/4-18	1.51	-	.62	FD41-1013-04-04	9
							10
							11
							12
							13
							14
							15
							16
<p>Male Half Male Pipe/Non-Valved</p>	-04	1/4-18	1.61	-	.56	FD41-1014-04-04	17
							18
							19
							20
							21
							22
							23
							24



## FD43 Series/Industrial Interchange—Air

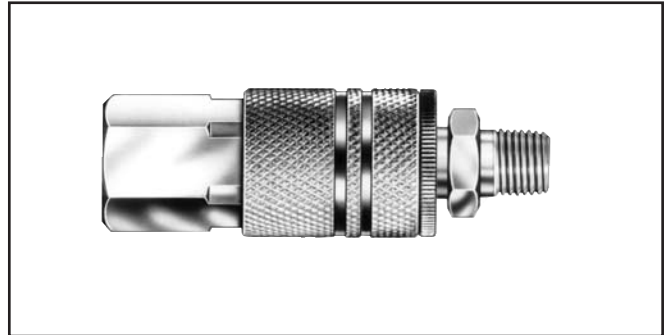
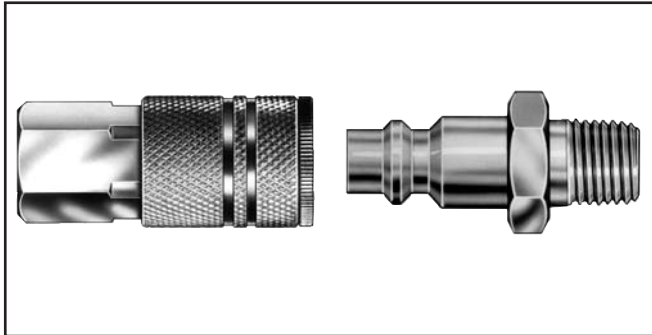
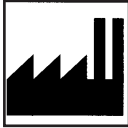

The FD43 Series is a manual retract-type ball latch industrial interchange coupling. Ideal for compressed air service, the FD43 uses FD40 male tips.

- Meets dimensional requirements of MIL-C-4109 specifications for industrial interchangeability.
- Protective collar to prevent accidental snagging and disconnection.
- Manual retract latch design allows quick and easy connection of hose lines.
- Swivels 360°, eliminating hose kinking.
- Standard seal material – Neoprene.
- Standard body material – Zinc plated steel.

### Flow Data

FD43 SERIES  
PRESSURE DROP VERSUS FLOW GRAPH

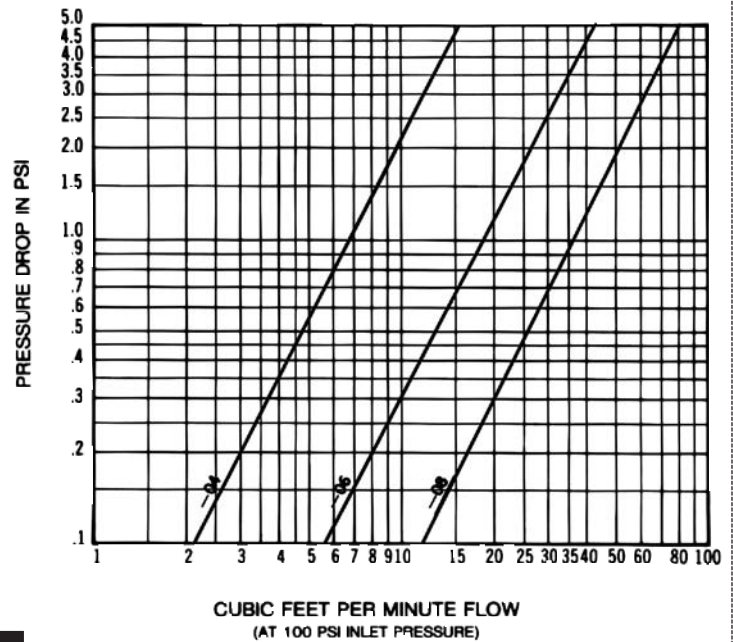

### Physical Characteristics

Coupling Dash Size	Maximum Operating Pressure (psi)	Minimum Burst Pressure (psi)		Vacuum (in./Hg.) Connected Only
		Female Half Only	Connected	
-04	300	3000	8000	Not Rated
-06	300	3000	8000	Not Rated
-08	300	2000	8000	Not Rated



FD43 Series	Coupling Size	Thread Size(P)	Hose I.D.	Dimensional Data			Part Number Neoprene	Line Ref.
				A	B	$\sqrt{Y}$		
<b>Female Half Female Pipe/Valved</b> 	-04	1/8-27		1.88	.88	.75	FD43-1001-02-04	1
	-04	1/4-18		2.09	.88	.75	FD43-1001-04-04	2
	-04	3/8-18		2.16	.88	.81	FD43-1001-06-04	3
	-06	1/4-18		2.38	1.06	.88	FD43-1001-04-06	4
	-06	3/8-18		2.38	1.06	.88	FD43-1001-06-06	5
	-06	1/2-14		2.53	1.06	1.00	FD43-1001-08-06	6
	-08	1/2-14		3.06	1.19	1.00	FD43-1001-08-08	7
<b>Female Half Male Pipe/Valved</b> 	-04	1/8-27		2.19	.88	.75	FD43-1011-02-04	8
	-04	1/4-18		2.28	.88	.75	FD43-1011-04-04	9
	-04	3/8-18		2.34	.88	.75	FD43-1011-06-04	10
	-06	1/4-18		2.41	1.06	.88	FD43-1011-04-06	11
	-06	3/8-18		2.44	1.06	.88	FD43-1011-06-06	12
	-06	1/2-14		2.56	1.06	.88	FD43-1011-08-06	13
	-08	1/2-14		3.09	1.19	1.00	FD43-1011-08-08	14
<b>Female Half SOCKETLESS™ Hose Barb/Valved</b> 	-04		1/4	2.78	.88	.75	FD43-1031-04-04	15
	-04		3/8	2.78	.88	.75	FD43-1031-06-04	16
								17
								18
								19
								20
								21
<b>Male Half Female Pipe/Non-Valved</b> 	-04	1/8-27		1.21		.56	FD40-1013-02-04	22
	-04	1/4-18		1.62		.62	FD40-1013-04-04	23
	-04	3/8-18		1.80		.88	FD40-1013-06-04	24
	-06	3/8-18		1.90		.88	FD40-1013-06-06	25
	-08	1/2-14		2.40		1.12	FD40-1013-08-08	26
								27
								28
<b>Male Half Male Pipe/Non-Valved</b> 	-04	1/8-27		1.50		.50	FD40-1014-02-04	29
	-04	1/4-18		1.75		.56	FD40-1014-04-04	30
	-04	3/8-18		1.75		.69	FD40-1014-06-04	31
	-06	1/4-18		1.88		.62	FD40-1014-04-06	32
	-06	3/8-18		1.88		.69	FD40-1014-06-06	33
	-06	1/2-14		2.13		.88	FD40-1014-08-06	34
	-08	3/8-18		2.18		.69	FD40-1014-06-08	35
	-08	1/2-14		2.44		.88	FD40-1014-08-08	36



## FD14 Series/Drain Coupling

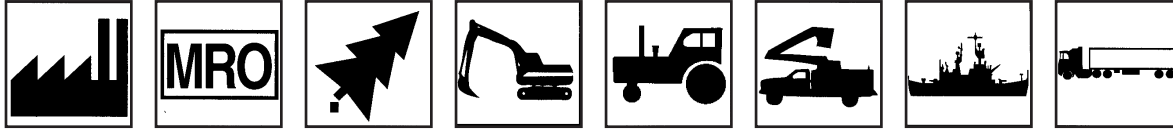

The FD14 Drain coupling is designed to serve as a drain port for use with systems such as the Eaton FLOCS (Fast Lube Oil Change System) as well as providing a purging port for use during refill operations.

- Low-Profile, with multiple sealing mechanisms
  - O-ring – primary seal
  - Metal-to-metal – Secondary Seal
  - Protective cap - Secondary Seal
- Push-To-Connect female half for easy one-hand operation
- Broad range of standard thread styles for Male Half
  - Utilizes a Copper-Crush gasket to seat against the port face.
- Standard male half seal material - Viton
- Standard female half seal material - Buna-N
- Standard body material - Zinc plated steel with zinc die-cast valve
- Rubber molded cap
  - Standard material - Buna-N

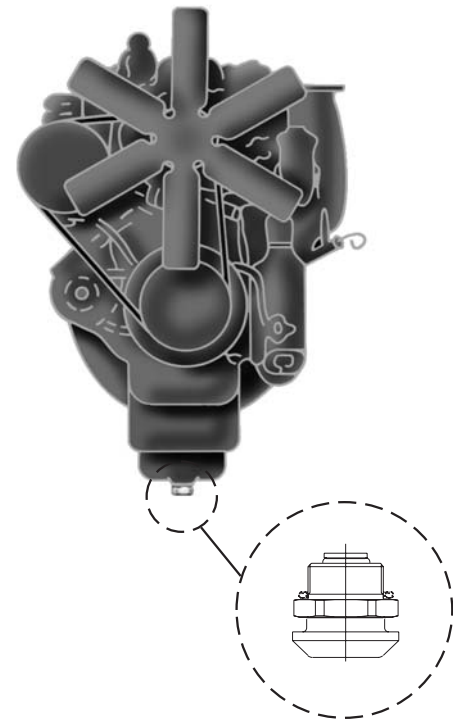

### Physical Characteristics

Coupling Size	Maximum Operating Pressure (psi)	Minimum Burst Pressure (psi)	Vacuum (in./Hg.)	Rated Flow (gpm)
-06	50	200	28	3





# Eaton FD14 Drain Coupling

**Providing direct access for fast oil changes.**

The FLOCS Direct Access Conversion Kit uses the Eaton-developed FD14 Drain Coupling as an alternative to the standard remote hose kit. This coupling design permits easy, one-hand connection and disconnection of the evacuation unit's hose.

Male Half Ass'y

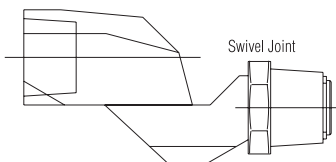
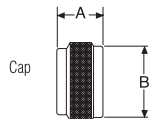
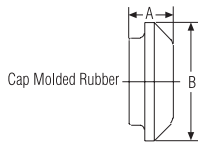
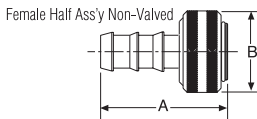
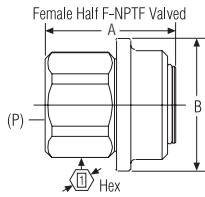
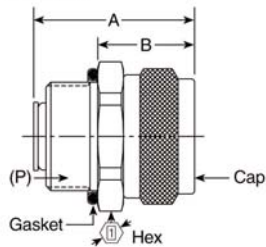

Coupling Size	Thread Size (P)	A	B	Min. Ass'y Torque (Ft-Lbs.)	Assembly† (Includes Gasket & Cap)	Gasket (Copper-Crush)	Cap (Brass)
-06	1/2 - 20 UNF - 2A	1.52	.96	1 1/16	20-24*	FD14-4002-01-06**	FD14-1210-06
-06	M18 x 1.5 6g	1.52	.96	1 1/4	20-40*	FD14-4002-02-06**	FD14-1210-06
-06	M14 x 1.25 6g	1.52	.96	1 1/16	20-24*	FD14-4002-03-06**	FD14-1210-06
-06	1 1/4 - 18 UNEF - 2A	1.54	.96	1 1/2	30-60*	FD14-4002-05-06††	FD14-1210-06
-06	1 - 18 UNS - 2A	1.54	.96	1 1/4	30-60*	FD14-4002-06-06††	FD14-1210-06
-06	7/8 - 18 UNS - 2A	1.54	.96	1 1/4	30-60*	FD14-4002-07-06††	FD14-1210-06
-06	5/8 - 18 UNF - 2A	1.52	.96	1 1/16	20-40*	FD14-4002-08-06**	FD14-1210-06
-06	3/4 - 16 UNF - 2A	1.54	.96	1 1/4	30-50*	FD14-4002-09-06††	FD14-1210-06
-06	7/8 - 14 UNF - 2A	1.54	.96	1 1/4	30-60*	FD14-4002-10-06††	FD14-1210-06
-06	M24 x 2 6g	1.54	.96	1 1/4	30-60*	FD14-4002-11-06††	FD14-1210-06
-06	9/16 - 18 UNF - 2A	1.52	.96	1 1/16	20-40*	FD14-4002-12-06**	FD14-1210-06
-06	1 1/8 - 12 UNF - 2A	1.54	.96	1 1/2	30-60*	FD14-4002-14-06††	FD14-1210-06
-06	M20 x 1.5 6g	1.54	.96	1 1/4	30-60*	FD14-4002-16-06††	FD14-1210-06
-06	M25 x 1.5 6g	1.54	.96	1 1/4	30-60*	FD14-4002-17-06††	FD14-1210-06
-06	M22 x 1.5 6g	1.54	.96	1 1/4	30-60*	FD14-4002-18-06††	FD14-1210-06
-06	M24 x 1.5 6g	1.54	.96	1 1/4	30-60*	FD14-4002-19-06††	FD14-1210-06
-06	1 1/16 - 12 UN - 2A	1.54	.96	1 1/2	30-60*	FD14-4002-20-06††	FD14-1210-06
-06	M30 x 1.5 6g	1.54	.96	1 1/2	30-60*	FD14-4002-21-06††	FD14-1210-06
-06	1/2 - 14 UNS - 2A	1.52	.96	1 1/16	20-24*	FD14-4002-22-06**	FD14-1210-06
-06	M12 x 1.5 6g	1.52	.96	1 1/16	20-24*	FD14-4002-23-06**	FD14-1210-06
-06	M14 x 1.5 6g	1.52	.96	1 1/16	20-24*	FD14-4002-24-06**	FD14-1210-06
-06	M12 x 1.75 6g	1.52	.96	1 1/16	20-24*	FD14-4002-25-06**	FD14-1210-06
-06	3/4 - 14 Dryseal NPTF	1.69	.96	1 1/4		FD14-4002-26-06††	None Needed
-06	1/2 - 14 Dryseal NPTF	1.60	.96	1 1/16		FD14-4002-27-06**	None Needed
-06	M27 x 2 6g	1.54	.96	1 1/2	30-60*	FD14-4002-29-06††	FD14-1210-06

\* ⚠ CAUTION: Failure to meet minimum assembly torque could result in fluid leakage.

† Note: FD14 with Rubber Cap can be ordered using FD14-1002-SIZE part numbering.

Coupling Size	Thread Size (P)	A	B	Assembly
-06	3/4 - 14 Dryseal NPTF	1.52	1.81	1 5/16 FD14-1001-12-06

Coupling Size	A	B	Thread Size (P)	Assembly
-06	2.34	1.50	5/8" F	FD14-4003-10-06

SOCKETLESS™

Coupling Size	A	B	Cap (Buna-N)
-06	0.519	1.400	FD14-1204-06

Coupling Size	A	B	Assembly
-06	0.726	1.25	FD14-1210-06

Coupling Size	Thread Size (P)	Assembly
-06	3/4 - 14 Dryseal NPTF	FD14-1004-12-12

## FLOCS System Components & Accessories



- FLOCS Oil Thief Sampling System

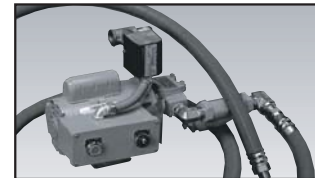

- FLOCS 15 Direct Access Oil Evacuation Unit (Electric)

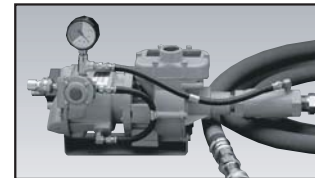

- FLOCS 30A Air Powered Oil Evacuation Unit



**FD15 Series/Oil Sampling Valve**

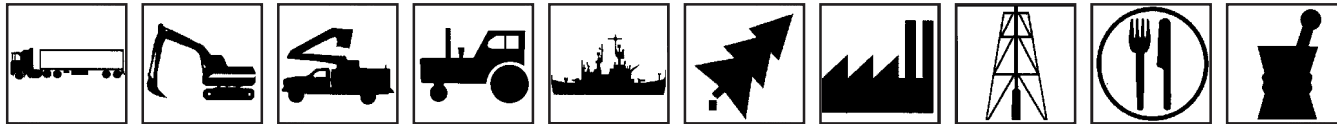

0-50 psi

**Part Number**  
FD15-1026-04  
FD15-1025-04

**Inlet Ports**  
1/4" NPTF  
7/16-20 Male ORB

As required in MIL-V-81940/2-1 this valve's flow rate is between 100 and 1500 milliliters per minute at pressures from 0-50 psi. (MIL-V-81940/2-1 applies only to pressures from 50-300 psi.)



50-300 psi

**Part Number**  
FD15-1000-02  
FD15-1000-04\*  
FD15-1002-04

**Inlet Ports**  
1/8" NPTF  
1/4" NPTF  
7/16-20 Male ORB

\*The 1/4" NPTF version is qualified to MIL-V-81940/2-1 and its performance is representative of the other inlet port configurations listed above.  
QPL-81940-9 6-5-89

**FD15 Oil Sampling Valve:** In-line sampling of system fluids is made without system shutdown, usually in less than one minute, and without fluid contamination.

**Application:** Engine oil, lubricating oil, transmission fluid and hydraulic fluids in mobile construction equipment, military vehicles, trucks and stationary equipment.

For best results, Eaton FD15 Oil Sampling Valves should be installed in dynamic fluid lines in low pressure and return lines. If only one sampling point can be chosen, it should be in the return line, upstream of any return line filter. This will insure a representative sample of all components in the fluid system for their present condition.

**Operation:** Remove metal dustcover on discharge port. Discharge approximately 200 ml of oil to flush valve by turning knurled knob 1/4 turn to the right. Dispose of this sample in the appropriate manner. Locate clean oil sample bottle under discharge port.

(Sample bottles are usually supplied by the oil analysis lab.) Turn knurled knob 1/4 turn to the right until bottle is filled to the desired level. The knob can be backed off to throttle the rate of flow. When bottle is filled let go of the knurled knob, the valve will close automatically. Replace metal dustcover wrench tight.

**Construction:** Corrosion resistant plated steel with brass internal components and Buna-N seal.

**Operating Temperature Range:** -65°F to +275°F (-53°C to +135°C)

**Minimum Burst Pressure:** 1200 psi

**Minimum Particle Restriction:** 500 microns

**Maximum Torque to Operate:** 10 in. lbs.

Note: This valve is not intended for aerospace applications.



FD15 Series	Coupling Size	Thread Size (P)	Dimensional Data						Part Number Buna-N	Line Ref.
			A	B	C	①	②	③		
<p>Male Pipe Thread 50-300 psi</p>	-	1/8-27	2.42	1.00	1.30	.69	.38	-	FD15-1000-02	1
	-	1/4-18	2.56	1.00	1.30	.69	.38	-	FD15-1000-04	2
										3
										4
										5
										6
										7
										8
<p>Male SAE O-Ring Thread 50-300 psi</p>	-	7/16-20	2.79	1.00	1.30	.69	.38	.56	FD15-1002-04	9
										10
										11
										12
										13
										14
										15
										16
<p>Male Pipe Thread 0-50 psi</p>	-	1/4-18	2.56	1.00	1.30	.69	.38	-	FD15-1026-04	17
										18
										19
										20
										21
										22
										23
										24
<p>Male SAE O-Ring Thread 0-50 psi</p>	-	7/16-20	2.79	1.00	1.30	.69	.38	.56	FD15-1025-04	25
										26
										27
										28
										29
										30
										31
										32



## FD35 Series/Arc Latch™ for 10,000 psi High Pressure Applications

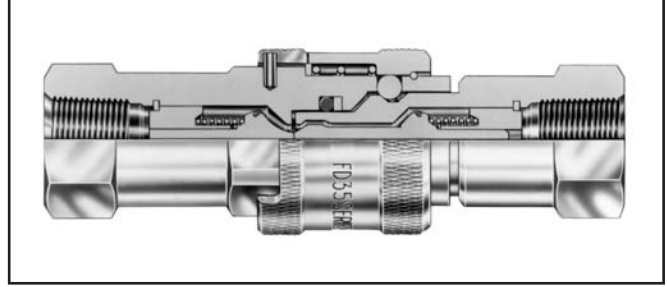
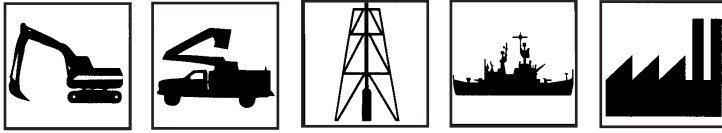

The FD35 Series Arc Latch™ design has a greater surface contact area for long surface life in rugged high pressure applications. The maximum operating pressure is 10,000 psi.

- Safety sleeve lock prevents accidental disconnection.
- Heavy duty back-up ring prevents O-ring extrusion.
- Heat treated and plated steel for greater wear and corrosion resistance.
- Self-sealing poppet valves provide excellent high and low pressure sealing.
- Standard seal material – Viton.
- Standard body material – Zinc plated steel.

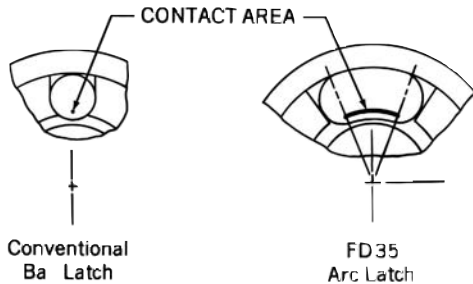

### Flow Data

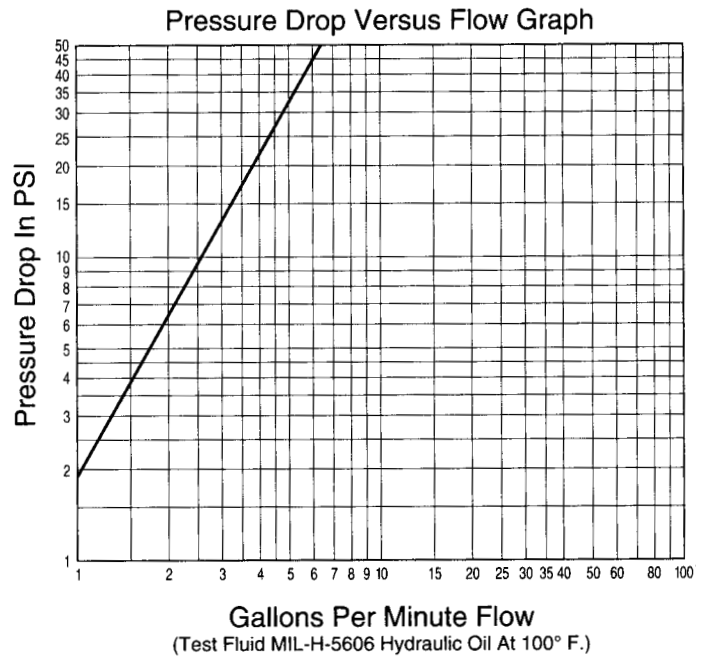



### Physical Characteristics

Coupling Size	Maximum Operating Pressure (psi)	Minimum Burst Pressure (psi)	Vacuum (in./Hg.)	Rated Flow (gpm)	Air Inclusion (cc. max.)	Fluid Loss (cc. max.)
-06	10,000	40,000	28	2	0.50	0.50

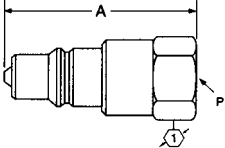
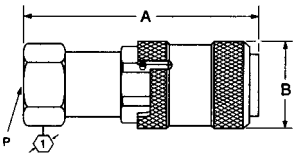
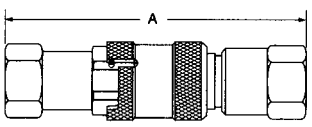
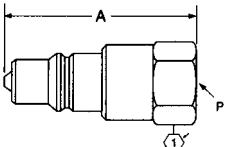
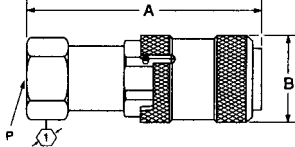

FD35 Series	Coupling Size	Thread Size (P)	Dimensional Data			Part Number Buna-N	Line Ref.
			A	B	(1)		
<b>Male Half Female Pipe/Valved</b>  	-06	3/8-18	2.05		0.94	FD35-1002-06-06	1
							2
							3
							4
							5
							6
							7
							8
<b>Female Half Female Pipe/Valved</b>  	-06	3/8-18	2.56	1.27	0.94	FD35-1001-06-06	9
							10
							11
							12
							13
							14
							15
							16
<b>Complete Coupling Female Pipe/Valved</b>  	-06	3/8-18	3.53			FD35-1000-06-06	17
							18
							19
							20
							21
							22
							23
							24
<b>Male Half Female SAE O-Ring/Valved</b>  	-06	9/16-18	2.05		0.94	FD35-1008-06-06	25
							26
							27
							28
							29
							30
							31
							32
<b>Female Half Female SAE O-Ring/Valved</b>  	-06	9/16-18	2.56	1.27	0.94	FD35-1007-06-06	33
							34
							35
							36
							37
							38
							39
							40

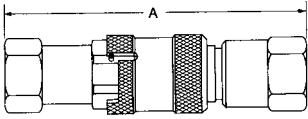
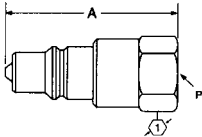
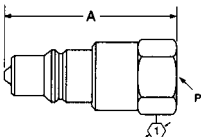

FD35 Series	Coupling Size	Thread Size(P)	Dimensional Data			Part Number Viton	Line Ref.
			A	B			
<b>Complete Coupling</b> Female SAE O-Ring/Valved 	-06	9/16-18	3.53			FD35-1006-06-06	1
							2
							3
							4
							5
							6
							7
							8
<b>Male Half</b> Female Pipe/45 psi Bleed Valve  Incorporates a special relief valve set at 45 psi, preventing disconnected pressure build-up.	-06	3/8-18	2.05		0.94	FD35-1043-06-06	9
							10
							11
							12
							13
							14
							15
							16
<b>Male Half</b> Female SAE O-Ring/ 45 psi Bleed Valve  Incorporates a special relief valve set at 45 psi, preventing disconnected pressure build-up.	-06	9/16-18	2.12		0.94	FD35-1044-06-06	17
							18
							19
							20
							21
							22
							23
							24
<b>Repair Kits</b>							25
	-06	Male Valving				FF10173-06	26
	-06	Female Valving				FF10174-06	27
	-06	Female Locking Arc Latch				FF10175-06	28
<b>Accessories</b>							29
<b>Dust Cover</b> 	-06	Fits Male and Female Halves				FD35-1042-06	30
							31
							32
							33
							34
							35
							36
							37



## FD42 Series/Pioneer 4000 Interchange

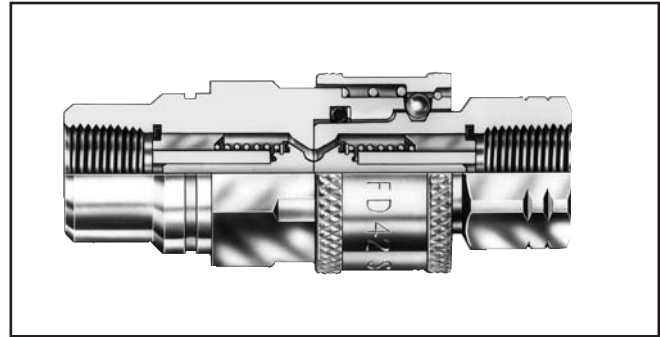
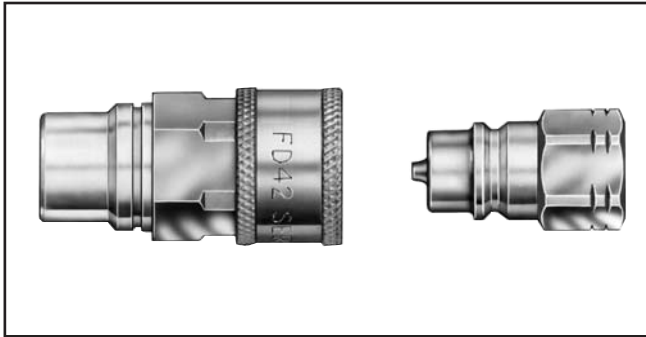
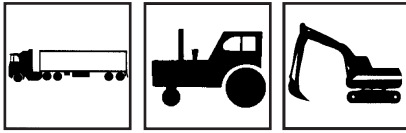

The FD42 Series coupling is designed as a Pioneer 4000 interchange to accommodate high surge flows typically found in snow plow applications. The maximum operating pressure is 3,000 psi.

- Teflon<sup>†</sup> back up ring in female half improves impulse life.
- Self-sealing poppet valve design provides excellent high and low pressure sealing.
- *PUSH-PULL*<sup>™</sup> ball latch design allows quick and easy connection and disconnection of hose lines.
- Interchanges with Pioneer 4000-2 and Safeway S20-A.
- Retaining groove on female half for bulkhead mounting.
- Male half can be bulkhead mounted with optional adapter.
- Standard seal material – Buna-N.
- Standard body material – Zinc plated steel with zinc poppet guides.

### Flow Data

Pressure Drop Versus Flow Graph

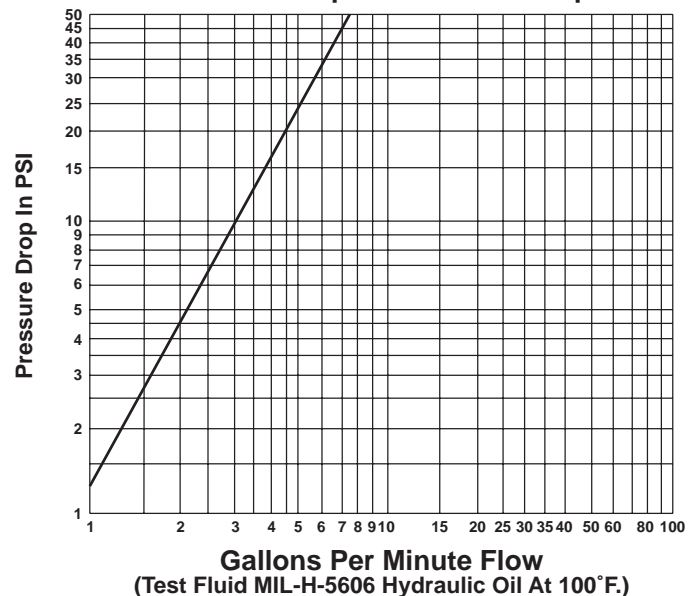

### Physical Characteristics

Coupling Size	Maximum Operating Pressure (psi)	Minimum Burst Pressure (psi)	Vacuum (in./Hg.)	Rated Flow (gpm)	Air Inclusion (cc. max.)	Fluid Loss (cc. max.)
-04	3000	12,000	28	3	.62	.80

<sup>†</sup> Teflon is a registered trademark of Dupont.



FD42 Series	Coupling Size	Thread Size (P)	Dimensional Data						Part Number Buna-N	Line Ref.
			A	B	C	D	E			
<b>Male Half Female Pipe/Valved</b>  	-04	1/4-18	1.34					.75	FD42-1002-04-04	1
										2
										3
										4
										5
										6
										7
										8
<b>Female Half Female Pipe/Valved</b>  	-04	1/4-18	2.04		.87	.05	.10	.88	FD42-1001-04-04	9
										10
										11
										12
										13
										14
										15
										16
<b>Complete Coupling Female Pipe/Valved</b>  	-04	1/4-18	2.68						FD42-1000-04-04	17
										18
										19
										20
										21
										22
										23
										24
<b>Male Half Female SAE O-Ring/Valved</b>  	-04	9/16-18	1.63					.81	FD42-1010-06-04	25
										26
										27
										28
										29
										30
										31
										32
<b>Female Half Female SAE O-Ring/Valved</b>  	-04	9/16-18	2.13	1.06	.87	.05	.10	.88	FD42-1008-06-04	33
										34
										35
										36
										37
										38
										39
										40
<b>Complete Coupling Female SAE O-Ring/Valved</b>  	-04	9/16-18	2.97						FD42-1006-06-04	41
										42
										43
										44
										45
										46
										47





FD42 Accessories	Coupling Size	Thread Size (P)	Dimensional Data						Part Number Buna-N	Line Ref.
			A	B	C	D	E			
<b>Bulkhead Adapter</b> 	-04	1/4-18	1.39	.87	.08			.88	FF1607-0404S	1
										2
										3
										4
										5
										6
										7
										8
<b>Dust Cap/Plug (Fits Both Halves)</b> 	-04								FD48-1042-04	9
										10
										11
										12
										13
										14
										15
										16



**FD45 Series/Industrial Interchange Series B ... (Steel)**

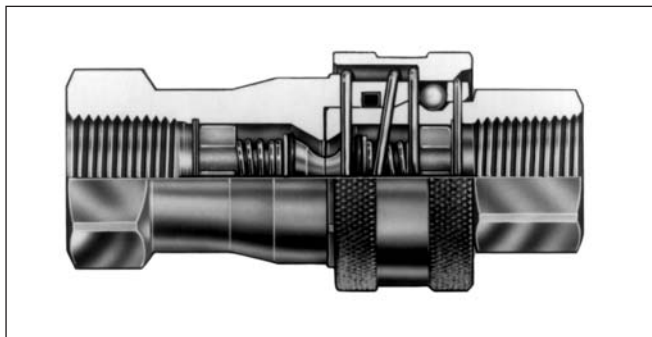
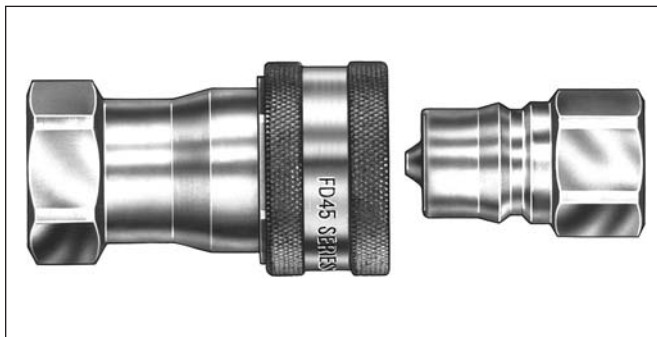

The FD45 Series steel is an industrial interchange popular in North America. Features rugged ball latch mechanism with automatic self-sealing poppet valves.

- Industrial interchange coupling conforming dimensionally to ISO standard 7241/1 Series B.
- *PUSH-PULL*™ ball latch design allows quick and easy connection and disconnection of hose lines.
- Self-sealing poppet valve design provides excellent high and low pressure sealing.
- Standard seal material – Buna-N, EPR and Viton.
- Standard body material – Zinc plated steel. (Brass poppet guide in -02 size.)

**Flow Data**

**Pressure Drop Versus Flow Graph**

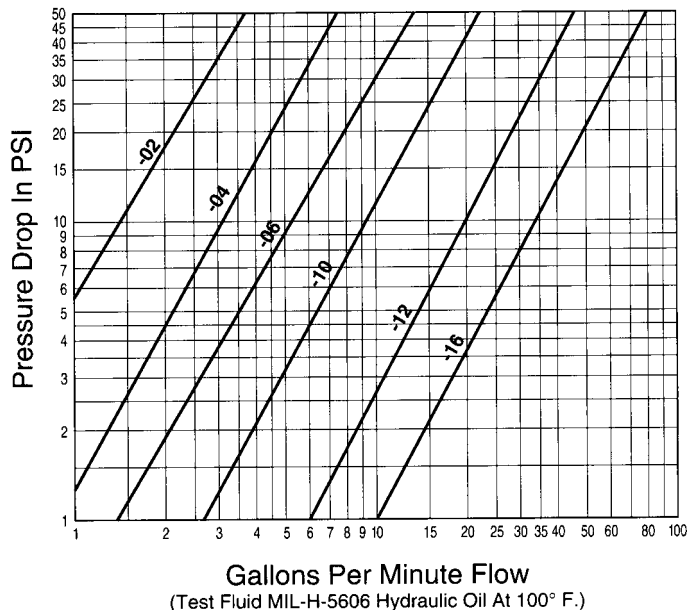

**Physical Characteristics**

Coupling Size	Maximum Operating Pressure (psi)	Minimum Burst Pressure (psi)	Vacuum (in./Hg.)	Rated Flow (gpm)	Air Inclusion (cc. max.)	Fluid Loss (cc. max.)
-02	4,500	13,500	28	1	.50	.50
-04	5,000	15,000	28	3	.50	.50
-06	4,000	12,000	28	6	2.5	1.3
-10	4,000	12,000	28	12	4.0	2.8
-12	4,000	12,000	28	28	11.0	8.2
-16	4,000	12,000	28	50	18.0	16.0



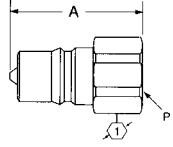
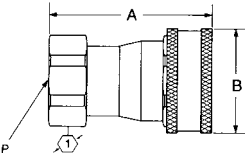
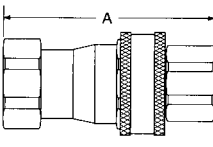
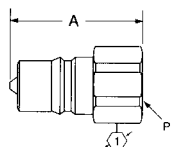
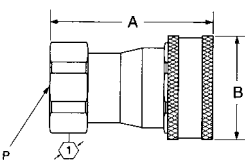

FD45 Steel	Coupling Size	Thread Size (P)	Dimensional Data			Part Number			Line Ref.
			A	B		Buna-N	Viton	EPR	
<p>Male Half Female Pipe/Valved</p> 	-02	1/8-27	1.28		.56	FD45-1002-02-02	FD45-1071-02-02	FD45-1064-02-02	1
	-04	1/4-18	1.50		.75	FD45-1002-04-04	FD45-1071-04-04	FD45-1064-04-04	2
	-06	3/8-18	1.66		.88	FD45-1002-06-06	FD45-1071-06-06	FD45-1064-06-06	3
	-10	1/2-14	1.93		1.06	FD45-1002-08-10	FD45-1071-08-10	FD45-1064-08-10	4
	-12	3/4-14	2.26		1.31	FD45-1002-12-12	FD45-1071-12-12	FD45-1064-12-12	5
	-16	1-11 1/2	2.72		1.62	FD45-1002-16-16	FD45-1071-16-16	FD45-1064-16-16	6
									7
								8	
<p>Female Half Female Pipe/Valved</p> 	-02	1/8-27	1.81	.96	.75	FD45-1003-02-02	FD45-1070-02-02	FD45-1065-02-02	9
	-04	1/4-18	2.22	1.13	.81	FD45-1003-04-04	FD45-1070-04-04	FD45-1065-04-04	10
	-06	3/8-18	2.45	1.38	1.06	FD45-1003-06-06	FD45-1070-06-06	FD45-1065-06-06	11
	-10	1/2-14	2.86	1.69	1.31	FD45-1003-08-10	FD45-1070-08-10	FD45-1065-08-10	12
	-12	3/4-14	3.40	2.06	1.62	FD45-1003-12-12	FD45-1070-12-12	FD45-1065-12-12	13
	-16	1-11 1/2	4.02	2.44	2.00	FD45-1003-16-16	FD45-1070-16-16	FD45-1065-16-16	14
									15
								16	
<p>Complete Coupling Female Pipe/Valved</p> 	-02	1/8-27	2.31			FD45-1000-02-02	FD45-1072-02-02	FD45-1063-02-02	17
	-04	1/4-18	2.74			FD45-1000-04-04	FD45-1072-04-04	FD45-1063-04-04	18
	-06	3/8-18	3.04			FD45-1000-06-06	FD45-1072-06-06	FD45-1063-06-06	19
	-10	1/2-14	3.54			FD45-1000-08-10	FD45-1072-08-10	FD45-1063-08-10	20
	-12	3/4-14	4.02			FD45-1000-12-12	FD45-1072-12-12	FD45-1063-12-12	21
	-16	1-11 1/2	4.88			FD45-1000-16-16	FD45-1072-16-16	FD45-1063-16-16	22
									23
								24	
<p>Male Half Female Pipe/Non-Valved</p>  <p>Will not operate with valved coupling halves. No valve actuator.</p>	-02	1/8-27	1.20		.56	FD45-1061-02-02	FD45-1061-02-02	FD45-1061-02-02	25
	-04	1/4-18	1.37		.75	FD45-1061-04-04	FD45-1061-04-04	FD45-1061-04-04	26
	-06	3/8-18	1.50		.88	FD45-1061-06-06	FD45-1061-06-06	FD45-1061-06-06	27
	-10	1/2-14	1.76		1.06	FD45-1061-08-10	FD45-1061-08-10	FD45-1061-08-10	28
	-12	3/4-14	2.00		1.31	FD45-1061-12-12	FD45-1061-12-12	FD45-1061-12-12	29
	-16	1-11 1/2	2.43		1.62	FD45-1061-16-16	FD45-1061-16-16	FD45-1061-16-16	30
									31
								32	
<p>Female Half Female Pipe/Non-Valved</p>  <p>Will not operate with valved coupling halves. No valve actuator.</p>	-02	1/8-27	1.81	.96	.75	FD45-1047-02-02	FD45-1172-02-02	FD45-1207-02-02	33
	-04	1/4-18	2.22	1.13	.81	FD45-1047-04-04	FD45-1172-04-04	FD45-1207-04-04	34
	-06	3/8-18	2.45	1.38	1.06	FD45-1047-06-06	FD45-1172-06-06	FD45-1207-06-06	35
	-10	1/2-14	2.86	1.69	1.31	FD45-1047-08-10	FD45-1172-08-10	FD45-1207-08-10	36
	-12	3/4-14	3.40	2.06	1.62	FD45-1047-12-12	FD45-1172-12-12	FD45-1207-12-12	37
	-16	1-11 1/2	4.02	2.44	2.00	FD45-1047-16-16	FD45-1172-16-16	FD45-1207-16-16	38
									39
								40	
<p><b>Repair Kit</b></p> <p>Each kit will repair one male or female half.</p>	-02					FF013-02†	FF014-02†	FF015-02†	42
	-04					FF013-04	FF014-04	FF015-04	43
	-06					FF013-06	FF014-06	FF015-06	44
	-10					FF013-10	FF014-10	FF015-10	45
	-12					FF013-12	FF014-12	FF015-12	46
	-16					FF013-16	FF014-16	FF015-16	47
									48
								49	

†The -02 coupling size valving is not repairable. This size repair kit contains an interface seal and back-up ring.

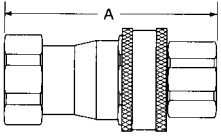
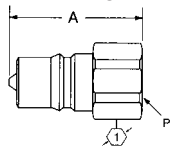
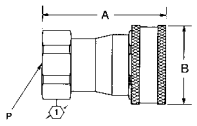
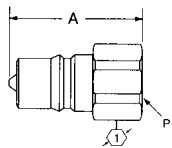
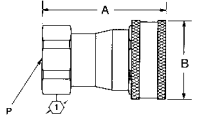

FD45 Steel	Coupling Size	Thread Size (P)	Dimensional Data			Part Number			Line Ref.
			A	B	$\phi$	Buna-N	Viton	EPR	
<b>Complete Coupling Female Pipe/Non-Valved</b> 	-02	1/8-27	2.31			FD45-1044-02-02	FD45-1173-02-02	FD45-1206-02-02	1
	-04	1/4-18	2.74			FD45-1044-04-04	FD45-1173-04-04	FD45-1206-04-04	2
	-06	3/8-18	3.04			FD45-1044-06-06	FD45-1173-06-06	FD45-1206-06-06	3
	-10	1/2-14	3.54			FD45-1044-08-10	FD45-1173-08-10	FD45-1206-08-10	4
	-12	3/4-14	4.02			FD45-1044-12-12	FD45-1173-12-12	FD45-1206-12-12	5
	-16	1-11 1/2	4.88			FD45-1044-16-16	FD45-1173-16-16	FD45-1206-16-16	6
									7
									8
<b>Male Half Female Pipe/Pusher Style Valving</b>  <p>Incorporates a pusher device to open mating valved coupling halves.</p>	-02	1/8-27	1.28		.56	FD45-1046-02-02	FD45-1046-02-02	FD45-1046-02-02	9
	-04	1/4-18	1.50		.75	FD45-1046-04-04	FD45-1046-04-04	FD45-1046-04-04	10
	-06	3/8-18	1.66		.88	FD45-1046-06-06	FD45-1046-06-06	FD45-1046-06-06	11
	-10	1/2-14	1.93		1.06	FD45-1046-08-10	FD45-1046-08-10	FD45-1046-08-10	12
	-12	3/4-14	2.26		1.31	FD45-1046-12-12	FD45-1046-12-12	FD45-1046-12-12	13
	-16	1-11 1/2	2.72		1.62	FD45-1046-16-16	FD45-1046-16-16	FD45-1046-16-16	14
									15
									16
<b>Female Half Female Pipe/Pusher Style Valving</b>  <p>Incorporates a pusher device to open mating valved coupling halves.</p>	-02	1/8-27	1.81	.96	.75	FD45-1045-02-02	FD45-1228-02-02	FD45-1229-02-02	17
	-04	1/4-18	2.22	1.13	.81	FD45-1045-04-04	FD45-1228-04-04	FD45-1229-04-04	18
	-06	3/8-18	2.45	1.38	1.06	FD45-1045-06-06	FD45-1228-06-06	FD45-1229-06-06	19
	-10	1/2-14	2.86	1.69	1.31	FD45-1045-08-10	FD45-1228-08-10	FD45-1229-08-10	20
	-12	3/4-14	3.40	2.06	1.62	FD45-1045-12-12	FD45-1228-12-12	FD45-1229-12-12	21
	-16	1-11 1/2	4.02	2.44	2.00	FD45-1045-16-16	FD45-1228-16-16	FD45-1229-16-16	22
									23
									24
<b>Male Half Female SAE O-ring/Valved</b> 	-04	9/16-18	1.68		0.81	FD45-1415-06-04		FD45-1238-06-04	
	-16	1 5/16-12	2.72		1.62	FD45-1168-16-16			
<b>Female Half Female SAE O-ring/Valved *With sleeve lock</b> 	-04	9/16-18	2.31		0.94	FD45-1414-06-04*		FD45-1237-06-04*	
	-16	1 5/16-12	4.02		2.00	FD45-1169-16-16			
<b>Repair Kit</b> Each kit will repair one male or female half.  †The -02 coupling size valving is not repairable. This size repair kit contains an interface seal and back-up ring.	-02					FF013-02†	FF014-02†	FF015-02†	26
	-04					FF013-04	FF014-04	FF015-04	27
	-06					FF013-06	FF014-06	FF015-06	28
	-10					FF013-10	FF014-10	FF015-10	29
	-12					FF013-12	FF014-12	FF015-12	30
	-16					FF013-16	FF014-16	FF015-16	31



Accessories	Coupling Size	Thread Size (P)	Dimensional Data			Buna-N	Part Number			Line Ref.
			A	B			Viton	EPR		
Dust Cap 	-02						FD45-1040-02		34	
	-04						FD45-1040-04		35	
	-06						FD45-1040-06		36	
	-10						FD45-1040-10		37	
	-12						FD45-1040-12		38	
	-16						FD45-1040-16		39	
Dust Plug 	-02						FD45-1041-02		41	
	-04						FD45-1041-04		42	
	-06						FD45-1041-06		43	
	-10						FD45-1041-10		44	
	-12						FD45-1041-12		45	
	-16						FD45-1041-16		46	



**FD45 Series/Industrial Interchange Series B . . . (Brass)**

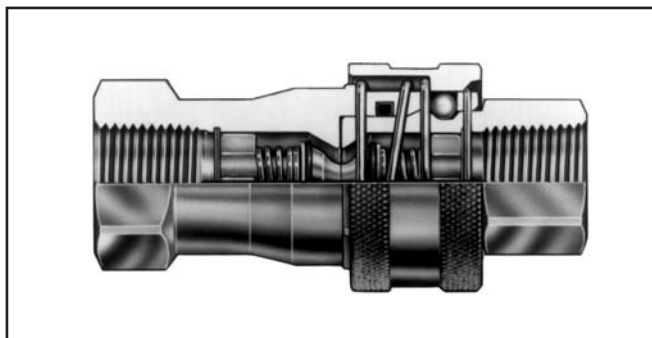
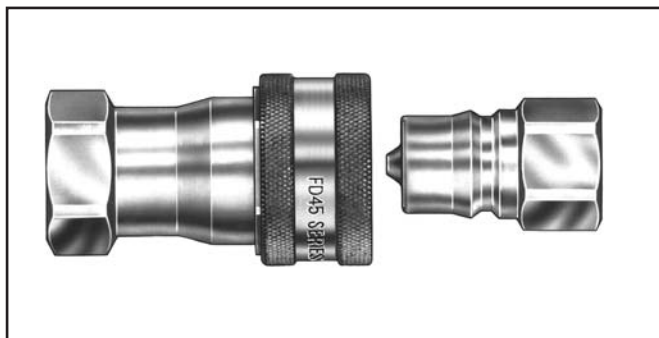
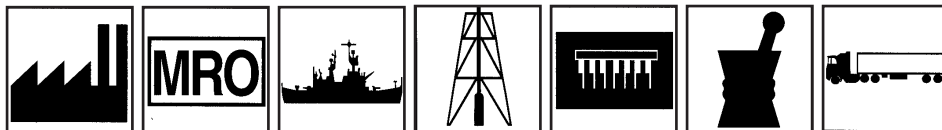

The FD45 Series brass industrial interchange coupling offers corrosion resistance where steel couplings are unacceptable. This general purpose coupling uses a *PUSH-PULL™* latch mechanism.

- Dual interface O-Rings in the female half provide redundant sealing while connected.
- Brass construction with stainless steel springs for greater corrosion resistance and fluid compatibility.
- Industrial interchange coupling conforming dimensionally to ISO standard 7241/1 Series B.
- *PUSH-PULL™* ball latch design allows quick and easy connection and disconnection of hose lines.
- Self-sealing poppet valves provide excellent high and low pressure sealing.
- Standard seal material – Buna-N, EPR and Viton.
- Standard body material – Brass with stainless steel springs and balls.

**Flow Data**

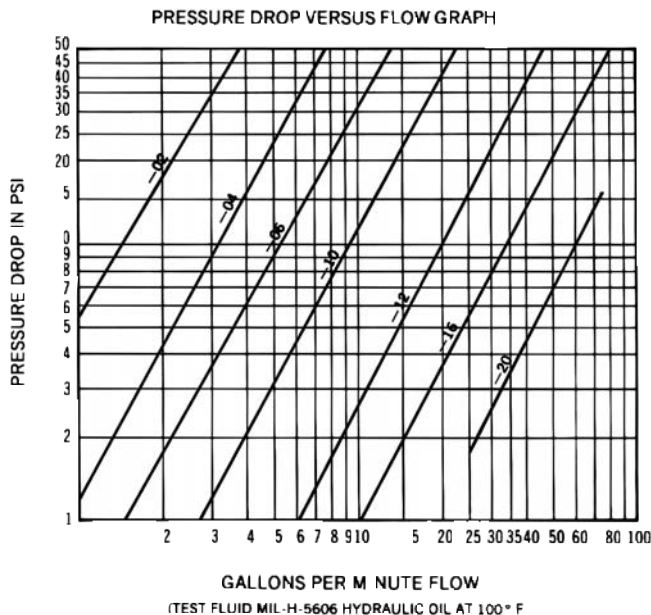



**Physical Characteristics**

Coupling Size	Maximum Operating Pressure (psi)	Minimum Burst Pressure		Vacuum (in./Hg.)	Rated Flow (gpm)	Air Inclusion (cc. max.)	Fluid Loss (cc. max)
		Connected (psi)	Disconnected (psi)				
-02	1,000	11,000	12,000	28	1	.50	.50
-04	1,000	18,000	14,000	28	3	.50	.50
-06	1,000	12,000	9,000	28	6	2.5	1.3
-10	1,000	12,000	6,500	28	12	4.0	2.8
-12	1,000	10,000	10,000	28	28	11.0	8.2
-16	1,000	8,500	11,000	28	50	18.0	16.0
-20	1,000	6,000	6,000	28	75	30.0	45.0

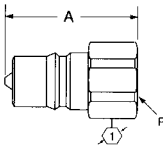
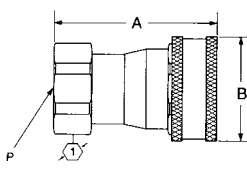
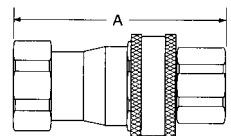
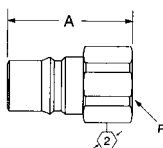
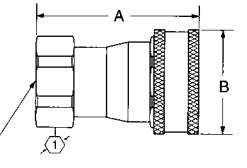

FD45 Brass	Coupling Size	Thread Size (P)	Dimensional Data			Part Number			Line Ref.
			A	B	$\Delta Y$	Buna-N	Viton	EPR	
<b>Male Half Female Pipe/Valved</b> 	-02	1/8-27	1.28		.56	FD45-1086-02-02	FD45-1092-02-02	FD45-1153-02-02	1
	-04	1/4-18	1.50		.69	FD45-1086-04-04	FD45-1092-04-04	FD45-1153-04-04	2
	-06	3/8-18	1.66		.88	FD45-1086-06-06	FD45-1092-06-06	FD45-1153-06-06	3
	-10	1/2-14	1.93		1.06	FD45-1086-08-10	FD45-1092-08-10	FD45-1153-08-10	4
	-12	3/4-14	2.26		1.31	FD45-1086-12-12	FD45-1092-12-12	FD45-1153-12-12	5
	-16	1-11 1/2	2.72		1.62	FD45-1086-16-16	FD45-1092-16-16	FD45-1153-16-16	6
	-20	1 1/4-11 1/2	4.25		2.38	FD45-1086-20-20	FD45-1092-20-20	FD45-1153-20-20	7
	Art is not representative of -20 size.								
<b>Female Half Female Pipe/Valved</b> 	-02	1/8-27	1.81	.96	.75	FD45-1101-02-02	FD45-1091-02-02	FD45-1156-02-02	9
	-04	1/4-18	2.22	1.13	.81	FD45-1101-04-04	FD45-1091-04-04	FD45-1156-04-04	10
	-06	3/8-18	2.45	1.38	1.06	FD45-1101-06-06	FD45-1091-06-06	FD45-1156-06-06	11
	-10	1/2-14	2.86	1.69	1.31	FD45-1101-08-10	FD45-1091-08-10	FD45-1156-08-10	12
	-12	3/4-14	3.40	2.01	1.62	FD45-1101-12-12	FD45-1091-12-12	FD45-1156-12-12	13
	-16	1-11 1/2	4.02	2.38	1.94	FD45-1101-16-16	FD45-1091-16-16	FD45-1156-16-16	14
	-20	1 1/4-11 1/2	4.49	2.62	2.38	FD45-1101-20-20	FD45-1091-20-20	FD45-1156-20-20	15
	Art is not representative of -20 size.								
<b>Complete Coupling Female Pipe/Valved</b> 	-02	1/8-27	2.31			FD45-1100-02-02	FD45-1090-02-02	FD45-1157-02-02	17
	-04	1/4-18	2.74			FD45-1100-04-04	FD45-1090-04-04	FD45-1157-04-04	18
	-06	3/8-18	3.04			FD45-1100-06-06	FD45-1090-06-06	FD45-1157-06-06	19
	-10	1/2-14	3.54			FD45-1100-08-10	FD45-1090-08-10	FD45-1157-08-10	20
	-12	3/4-14	4.02			FD45-1100-12-12	FD45-1090-12-12	FD45-1157-12-12	21
	-16	1-11 1/2	4.88			FD45-1100-16-16	FD45-1090-16-16	FD45-1157-16-16	22
	-20	1 1/4-11 1/2	6.80			FD45-1100-20-20	FD45-1090-20-20	FD45-1157-20-20	23
	Art is not representative of -20 size.								
<b>Male Half Female Pipe/Non-Valved</b>  <p>Will not operate with valved coupling halves. No valve actuator.</p>	-02	1/8-27	1.20		.56	FD45-1175-02-02	FD45-1175-02-02	FD45-1175-02-02	25
	-04	1/4-18	1.37		.69	FD45-1175-04-04	FD45-1175-04-04	FD45-1175-04-04	26
	-06	3/8-18	1.50		.88	FD45-1175-06-06	FD45-1175-06-06	FD45-1175-06-06	27
	-10	1/2-14	1.76		1.06	FD45-1175-08-10	FD45-1175-08-10	FD45-1175-08-10	28
	-12	3/4-14	2.00		1.31	FD45-1175-12-12	FD45-1175-12-12	FD45-1175-12-12	29
	-16	1-11 1/2	2.43		1.62	FD45-1175-16-16	FD45-1175-16-16	FD45-1175-16-16	30
	-20	1 1/4-11 1/2	4.25		2.38	FD45-1175-20-20	FD45-1399-20-20	FD45-1400-20-20	31
	Art is not representative of -20 size.								
<b>Female Half Female Pipe/Non-Valved</b>  <p>Will not operate with valved coupling halves. No valve actuator.</p>	-02	1/8-27	1.81	.96	.75	FD45-1176-02-02	FD45-1180-02-02	FD45-1178-02-02	33
	-04	1/4-18	2.22	1.13	.81	FD45-1176-04-04	FD45-1180-04-04	FD45-1178-04-04	34
	-06	3/8-18	2.45	1.38	1.06	FD45-1176-06-06	FD45-1180-06-06	FD45-1178-06-06	35
	-10	1/2-14	2.86	1.69	1.31	FD45-1176-08-10	FD45-1180-08-10	FD45-1178-08-10	36
	-12	3/4-14	3.40	2.01	1.62	FD45-1176-12-12	FD45-1180-12-12	FD45-1178-12-12	37
	-16	1-11 1/2	4.02	2.38	1.94	FD45-1176-16-16	FD45-1180-16-16	FD45-1178-16-16	38
	-20	1 1/4-11 1/2	4.49	2.62	2.38	FD45-1176-20-20	FD45-1180-20-20	FD45-1178-20-20	39
	Art is not representative of -20 size.								
<b>Repair Kit</b> Each kit will repair one male or female half.	-02					FF016-02†	FF017-02†	FF018-02†	41
	-04					FF016-04	FF017-04	FF018-04	42
	-06					FF016-06	FF017-06	FF018-06	43
	-10					FF016-10	FF017-10	FF018-10	44
	-12					FF016-12	FF017-12	FF018-12	45
	-16					FF016-16	FF017-16	FF018-16	46
	-20					FF016-20	FF017-20	FF018-20	47
	†The -02 coupling size valving is not repairable. This size repair kit contains an interface seal and back-up ring.								

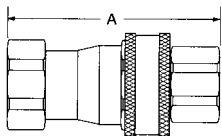
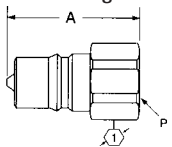
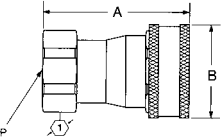

FD45 Brass	Coupling Size	Thread Size (P)	Dimensional Data			Part Number			Line Ref.	
			A	B		Buna-N	Viton	EPR		
<b>Complete Coupling Female Pipe/Non-Valved</b> 	-02	1/8-27	2.31			FD45-1174-02-02	FD45-1179-02-02	FD45-1177-02-02	1	
	-04	1/4-18	2.74			FD45-1174-04-04	FD45-1179-04-04	FD45-1177-04-04	2	
	-06	3/8-18	3.04			FD45-1174-06-06	FD45-1179-06-06	FD45-1177-06-06	3	
	-10	1/2-14	3.54			FD45-1174-08-10	FD45-1179-08-10	FD45-1177-08-10	4	
	-12	3/4-14	4.02			FD45-1174-12-12	FD45-1179-12-12	FD45-1177-12-12	5	
	-16	1-11 1/2	4.88			FD45-1174-16-16	FD45-1179-16-16	FD45-1177-16-16	6	
	-20	1 1/4-11 1/2	6.80			FD45-1174-20-20	FD45-1179-20-20	FD45-1177-20-20	7	
	Art is not representative of -20 size.									8
<b>Male Half Female Pipe/Pusher Style Valving</b>  <p>Incorporates a pusher device to open mating valved coupling halves.</p>	-04	1/4-18	1.50		.75	FD45-1201-04-04	FD45-1201-04-04	FD45-1201-04-04	9	
	-06	3/8-18	1.66		.88	FD45-1201-06-06	FD45-1201-06-06	FD45-1201-06-06	10	
	-10	1/2-14	1.93		1.06	FD45-1201-08-10	FD45-1201-08-10	FD45-1201-08-10	11	
	-12	3/4-14	2.26		1.31	FD45-1201-12-12	FD45-1201-12-12	FD45-1201-12-12	12	
	-16	1-11 1/2	2.72		1.62	FD45-1201-16-16	FD45-1201-16-16	FD45-1201-16-16	13	
									14	
									15	
<b>Female Half Female Pipe/Pusher Style Valving</b>  <p>Incorporates a pusher device to open mating valved coupling halves.</p>	-04	1/4-18	2.22	1.13	.88	FD45-1203-04-04	FD45-1199-04-04	FD45-1211-04-04	16	
	-06	3/8-18	2.45	1.38	1.06	FD45-1203-06-06	FD45-1199-06-06	FD45-1211-06-06	17	
	-10	1/2-14	2.86	1.69	1.31	FD45-1203-08-10	FD45-1199-08-10	FD45-1211-08-10	18	
	-12	3/4-14	3.40	2.01	1.62	FD45-1203-12-12	FD45-1199-12-12	FD45-1211-12-12	19	
	-16	1-11 1/2	4.02	2.38	1.94	FD45-1203-16-16	FD45-1199-16-16	FD45-1211-16-16	20	
									21	
<b>Repair Kit</b> Each kit will repair one male or female half.	-02					FF016-02†	FF017-02†	FF018-02†	22	
	-04					FF016-04	FF017-04	FF018-04	23	
	-06					FF016-06	FF017-06	FF018-06	24	
	-10					FF016-10	FF017-10	FF018-10	25	
	-12					FF016-12	FF017-12	FF018-12	26	
	-16					FF016-16	FF017-16	FF018-16	27	
	-20					FF016-20	FF017-20	FF018-20	28	
									29	
<b>Accessories</b>									30	
	<b>Dust Cap</b> 	-02						FD45-1040-02		31
		-04						FD45-1040-04		32
		-06						FD45-1040-06		33
		-10						FD45-1040-10		34
		-12						FD45-1040-12		35
		-16						FD45-1040-16		36
									37	
<b>Dust Plug</b> 	-02						FD45-1041-02		38	
	-04						FD45-1041-04		39	
	-06						FD45-1041-06		40	
	-10						FD45-1041-10		41	
	-12						FD45-1041-12		42	
	-16						FD45-1041-16		43	
								44		
								45		
								46		
								47		





## FD45 Series/Industrial Interchange Series B . . . (Stainless Steel)

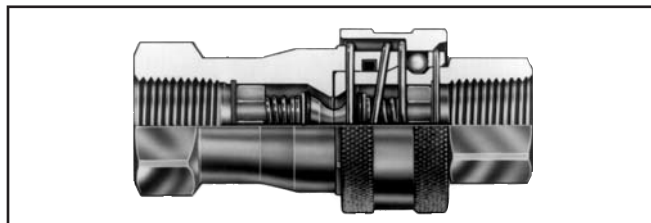
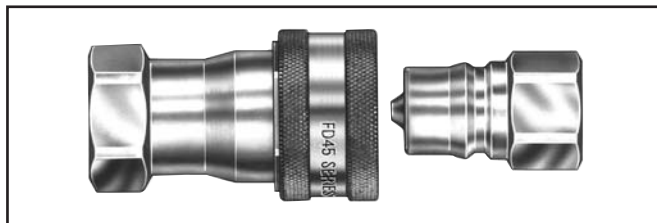
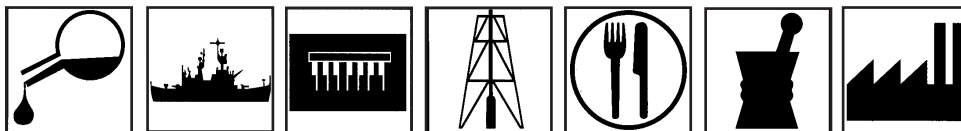

The FD45 stainless steel is a general purpose industrial interchange coupling available valved or non-valved. Offered in 303/304 grades of stainless steel for excellent corrosion resistance in rugged applications.

- Industrial interchange coupling conforming dimensionally to ISO standard 7241/1 Series B.
- Stainless steel construction for greater corrosion resistance and fluid compatibility.
- *PUSH-PULL*<sup>™</sup> ball latch design allows quick and easy connection and disconnection of hose lines.
- Self-sealing poppet valves provide excellent high and low pressure sealing.
- Standard seal material – Buna-N, EPR and Viton.
- Standard body material – Stainless Steel.

### Flow Data

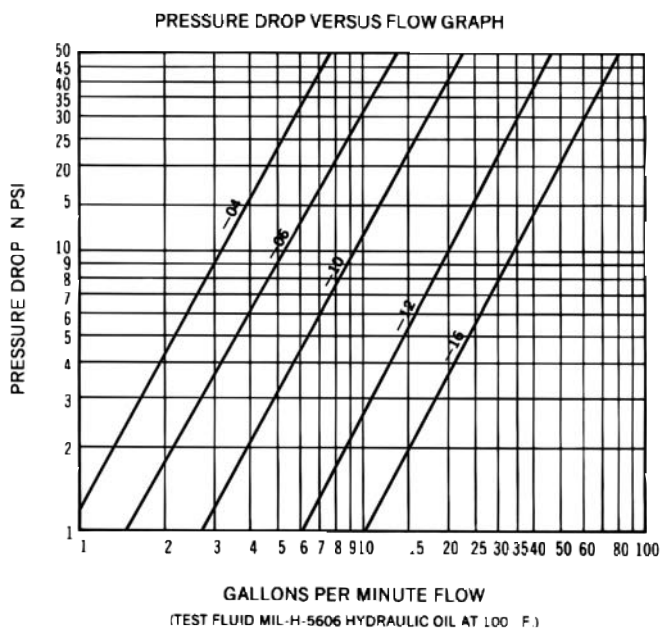



### Physical Characteristics

Coupling Size	Maximum Operating Pressure		Minimum Burst Pressure (psi)	Vacuum (in./Hg.)	Rated Flow (gpm)	Air Inclusion (cc. max.)	Fluid Loss (cc. max.)
	Hydraulic (psi)	Static (psi)					
-04	3,000	3,000	12,000	28	3	.50	.50
-06	1,500	3,000	12,000	28	6	2.5	1.3
-10	1,500	3,000	12,000	28	12	4.0	2.8
-12	1,500	3,000	12,000	28	28	11.0	8.2
-16	1,250	3,000	12,000	28	50	18.0	16.0

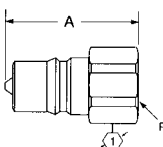
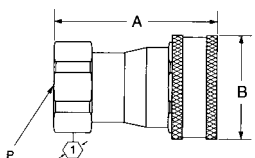
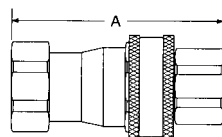
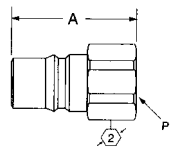
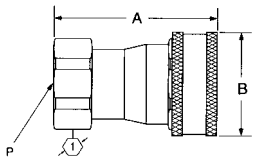

FD45 Stainless Steel	Coupling Size	Thread Size (P)	Dimensional Data			Part Number			Line Ref.
			A	B	$\phi$	Buna-N	Viton	EPR	
Male Half Female Pipe/Valved 	-04	1/4-18	1.46		.69	FD45-1004-04-04	FD45-1078-04-04	FD45-1121-04-04	1
	-06	3/8-18	1.66		.88	FD45-1004-06-06	FD45-1078-06-06	FD45-1121-06-06	2
	-10	1/2-14	1.89		1.06	FD45-1004-08-10	FD45-1078-08-10	FD45-1121-08-10	3
	-12	3/4-14	2.26		1.31	FD45-1004-12-12	FD45-1078-12-12	FD45-1121-12-12	4
	-16	1-11 1/2	2.72		1.62	FD45-1004-16-16	FD45-1078-16-16	FD45-1121-16-16	5
Female Half Female Pipe/Valved 	-04	1/4-18	2.22	1.13	.81	FD45-1005-04-04	FD45-1076-04-04	FD45-1122-04-04	9
	-06	3/8-18	2.45	1.38	1.06	FD45-1005-06-06	FD45-1076-06-06	FD45-1122-06-06	10
	-10	1/2-14	2.86	1.69	1.31	FD45-1005-08-10	FD45-1076-08-10	FD45-1122-08-10	11
	-12	3/4-14	3.40	2.01	1.62	FD45-1005-12-12	FD45-1076-12-12	FD45-1122-12-12	12
	-16	1-11 1/2	4.02	2.38	2.00	FD45-1005-16-16	FD45-1076-16-16	FD45-1122-16-16	13
Complete Coupling Female Pipe/Valved 	-04	1/4-18	2.70			FD45-1001-04-04	FD45-1075-04-04	FD45-1120-04-04	17
	-06	3/8-18	3.04			FD45-1001-06-06	FD45-1075-06-06	FD45-1120-06-06	18
	-10	1/2-14	3.50			FD45-1001-08-10	FD45-1075-08-10	FD45-1120-08-10	19
	-12	3/4-14	4.02			FD45-1001-12-12	FD45-1075-12-12	FD45-1120-12-12	20
	-16	1-11 1/2	4.88			FD45-1001-16-16	FD45-1075-16-16	FD45-1120-16-16	21
Male Half Female Pipe/Non-Valved 	-04	1/4-18	1.33		.69	FD45-1062-04-04	FD45-1062-04-04	FD45-1062-04-04	25
	-06	3/8-18	1.50		.88	FD45-1062-06-06	FD45-1062-06-06	FD45-1062-06-06	26
	-10	1/2-14	1.72		1.06	FD45-1062-08-10	FD45-1062-08-10	FD45-1062-08-10	27
	-12	3/4-14	2.00		1.31	FD45-1062-12-12	FD45-1062-12-12	FD45-1062-12-12	28
	-16	1-11 1/2	2.43		1.62	FD45-1062-16-16	FD45-1062-16-16	FD45-1062-16-16	29
Will not operate with valved coupling halves. No valve actuator.									
Female Half Female Pipe/Non-Valved 	-04	1/4-18	2.22	1.13	.81	FD45-1053-04-04	FD45-1195-04-04	FD45-1142-04-04	33
	-06	3/8-18	2.45	1.38	1.06	FD45-1053-06-06	FD45-1195-06-06	FD45-1142-06-06	34
	-10	1/2-14	2.86	1.69	1.31	FD45-1053-08-10	FD45-1195-08-10	FD45-1142-08-10	35
	-12	3/4-14	3.40	2.01	1.62	FD45-1053-12-12	FD45-1195-12-12	FD45-1142-12-12	36
	-16	1-11 1/2	4.02	2.38	2.00	FD45-1053-16-16	FD45-1195-16-16	FD45-1142-16-16	37
Will not operate with valved coupling halves. No valve actuator.									
<b>Repair Kit</b> Each kit will repair one male or female half.	-04					FF054-04	FF055-04	FF056-04	42
	-06					FF054-06	FF055-06	FF056-06	43
	-10					FF054-10	FF055-10	FF056-10	44
	-12					FF054-12	FF055-12	FF056-12	45
	-16					FF054-16	FF055-16	FF056-16	46
									48

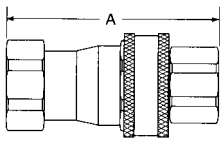
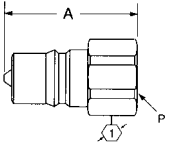
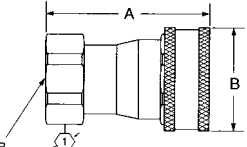

FD45 Stainless Steel	Coupling Size	Thread Size(P)	Dimensional Data			Part Number			Line Ref.
			A	B	$\alpha$	Buna-N	Viton	EPR	
<b>Complete Coupling Female Pipe/Non-Valved</b> 	-04	1/4-18	2.70			FD45-1052-04-04	FD45-1194-04-04	FD45-1143-04-04	1
	-06	3/8-18	3.04			FD45-1052-06-06	FD45-1194-06-06	FD45-1143-06-06	2
	-10	1/2-14	3.50			FD45-1052-08-10	FD45-1194-08-10	FD45-1143-08-10	3
	-12	3/4-14	4.02			FD45-1052-12-12	FD45-1194-12-12	FD45-1143-12-12	4
	-16	1-11 1/2	4.88			FD45-1052-16-16	FD45-1194-16-16	FD45-1143-16-16	5
<b>Male Half Female Pipe/Pusher Style Valving</b>  <p>Incorporates a pusher device to open mating coupling halves</p>	-04	1/4-18	1.46		.69	FD45-1059-04-04	FD45-1059-04-04	FD45-1059-04-04	9
	-06	3/8-18	1.66		.88	FD45-1059-06-06	FD45-1059-06-06	FD45-1059-06-06	10
	-10	1/2-14	1.89		1.06	FD45-1059-08-10	FD45-1059-08-10	FD45-1059-08-10	11
	-12	3/4-14	2.26		1.31	FD45-1059-12-12	FD45-1059-12-12	FD45-1059-12-12	12
	-16	1-11 1/2	2.72		1.62	FD45-1059-16-16	FD45-1059-16-16	FD45-1059-16-16	13
<b>Female Half Female Pipe/Pusher Style Valving</b>  <p>Incorporates a pusher device to open mating coupling halves</p>	-04	1/4-18	2.22	1.13	.81	FD45-1056-04-04	FD45-1197-04-04	FD45-1209-04-04	17
	-06	3/8-18	2.45	1.38	1.06	FD45-1056-06-06	FD45-1197-06-06	FD45-1209-06-06	18
	-10	1/2-14	2.86	1.69	1.31	FD45-1056-08-10	FD45-1197-08-10	FD45-1209-08-10	19
	-12	3/4-14	3.40	2.01	1.62	FD45-1056-12-12	FD45-1197-12-12	FD45-1209-12-12	20
	-16	1-11 1/2	4.02	2.38	2.00	FD45-1056-16-16	FD45-1197-16-16	FD45-1209-16-16	21
<b>Repair Kit</b> Each kit will repair one male or female half	-04					FF054-04	FF055-04	FF056-04	26
	-06					FF054-06	FF055-06	FF056-06	27
	-10					FF054-10	FF055-10	FF056-10	28
	-12					FF054-12	FF055-12	FF056-12	29
	-16					FF054-16	FF055-16	FF056-16	30
									31
<b>Accessories</b> <b>Dust Cap</b> 	-04						FD45-1040-04		34
	-06						FD45-1040-06		35
	-10						FD45-1040-10		36
	-12						FD45-1040-12		37
	-16						FD45-1040-16		38
									32
<b>Dust Plug</b> 	-04						FD45-1041-04		39
	-06						FD45-1041-06		40
	-10						FD45-1041-10		41
	-12						FD45-1041-12		42
	-16						FD45-1041-16		43

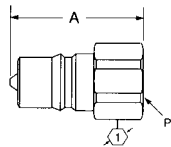
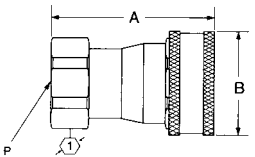
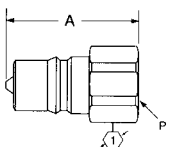
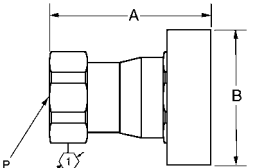

FD45 Stainless Steel	Coupling Size	Thread Size (P)	Dimensional Data			Part Number	Line Ref.
			A	B			
Male Half Female SAE O-Ring/Valved 	-06	3/4-16	2.04		1.06	FD45-1417-08-06	1
							2
							3
							4
							5
							6
							7
							8
	Female Half Female SAE O-Ring/Valved 	-06	3/4-16	2.45		1.06	FD45-1411-08-06
							10
							11
							12
							13
							14
							15
							16
*Fryer Coupling/Male Half Female Pipe/Valved 		-10	1/2-14	1.92		1.06	FD45-1270-08-10
							18
							19
							20
							21
							22
							23
							24
	*Fryer Coupling/Female Half Female Pipe/Valved Silicone Collar on Ball Release Sleeve 	-10	1/2-14	2.86	2.38	1.31	FD45-1267-08-10
							26
							27
							28
							29
							30
							31
							32

\*Special internal Viton seal material approved for use by the National Sanitation Foundation. The fryer coupling uses a silicone collar aiding disconnection with hot fluid applications.

Connecting and disconnecting lines between deep fat fryers and oil recycling units has been made cleaner, safer and quicker with Eaton's new FD45 "Fryer" coupling.

Eaton's FD45 "Fryer" coupling is made of stainless steel with Viton\* seal material. It has a silicone rubber collar on the sleeve of the female half to provide insulation from high oil temperatures and an excellent gripping surface during connection and disconnection. The coupling has been approved for use by the National Sanitation Foundation.



## FD48 Series/Parker Bruning – SM Interchange

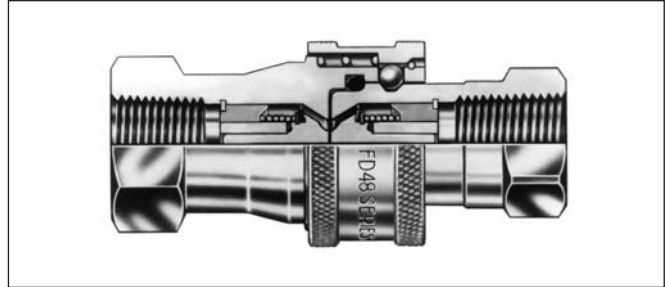

The FD48 Series coupling is designed to interchange with Parker Bruning SM-250 couplings.

- Self-sealing poppet valves provide excellent high and low pressure sealing.
- *PUSH-PULL*<sup>™</sup> ball latch design allows quick and easy connection and disconnection of fluid lines.
- Heat-treated and plated steel for wear and corrosion resistance.
- 3,000 psi operating pressure.
- Standard seal material – Buna-N.
- Standard seal material – Zinc plated steel with zinc poppet guides.

### Flow Data

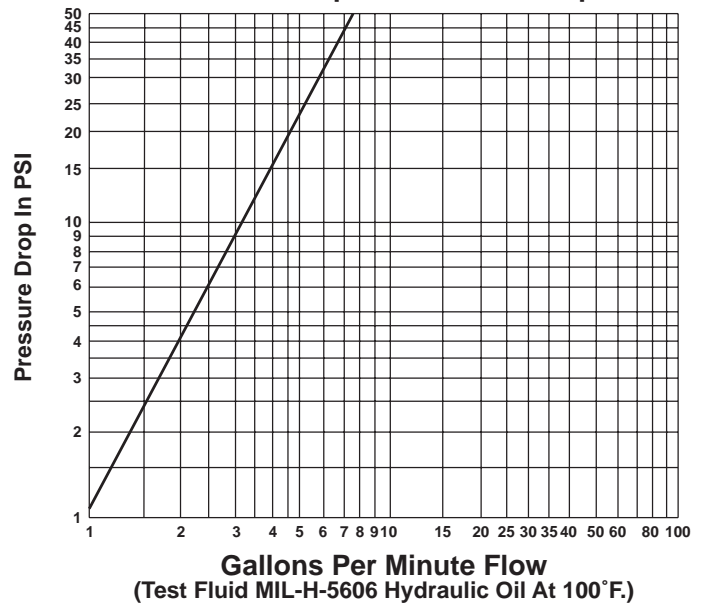

Pressure Drop Versus Flow Graph



### Physical Characteristics

Coupling Size	Maximum Operating Pressure (psi)	Minimum Burst Pressure (psi)	Vacuum (in./Hg.)	Rated Flow (gpm)	Air Inclusion (cc. max.)	Fluid Loss (cc. max.)
-04	3,000	12,000	28	3	0.50	1.10

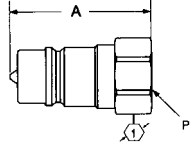
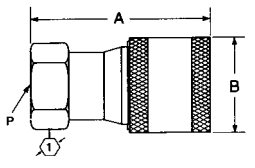
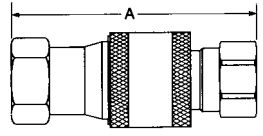

FD48 Series	Coupling Size	Thread Size (P)	Dimensional Data			Part Number Buna-N	Line Ref.
			A	B			
<b>Male Half Female Pipe/Valved</b>  	-04	1/4-18	1.45		.75	FD48-1002-04-04	1
							2
							3
							4
							5
							6
							7
							8
<b>Female Half Female Pipe/Valved</b>  	-04	1/4-18	2.01	1.06	.81	FD48-1001-04-04	9
							10
							11
							12
							13
							14
							15
							16
<b>Complete Coupling Female Pipe/Valved</b>  	-04	1/4-18	2.69			FD48-1000-04-04	17
							18
							19
							20
							21
							22
							23
							24
<b>Accessories</b>							25
<b>Dust Cap/Plug</b> (Fits both male and female halves)  	-04					FD48-1042-04	26
							27
							28
							29
							30
							31
							32



## FD49 Series/HTMA Flush Face, Hydraulic Tool

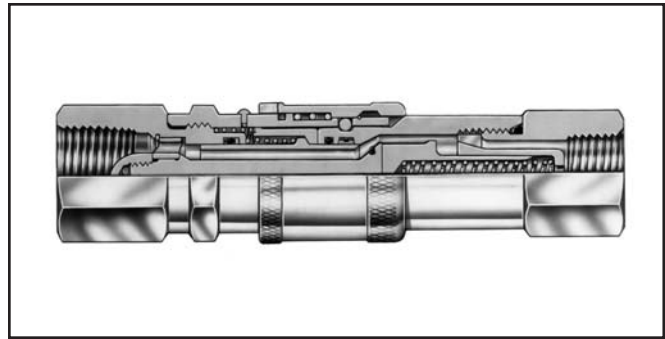

The FD49 Series meets NFPA standard T3.20.15, which was developed in conjunction with HTMA (Hydraulic Tool Manufacturer's Association).

- Twin-Guard™ sealing system prevents weepage and allows connection and disconnection against pressure up to 500 psi.
- Dual flush face valving for minimal fluid loss and air inclusion.
- Tubular valve and sleeve construction for high fluid flow with low pressure drop.
- Push-to-connect latching for one hand operation.
- Standard seal material – Teflon channel seal and Buna-N O-Ring backup.
- Standard body material – Zinc plated steel.

### Flow Data

Pressure Drop Versus Flow Graph

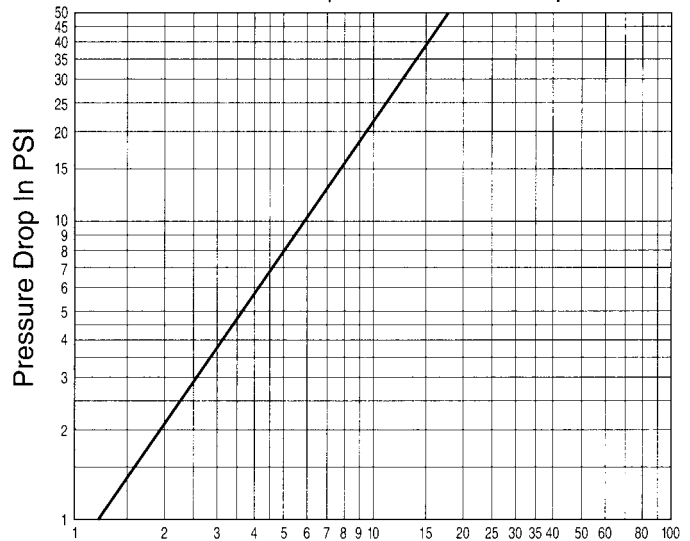

Gallons Per Minute Flow  
(Test Fluid MIL-H-5606 Hydraulic Oil At 100° F.)



Our patented\* Twin-Guard™ seal system consists of channel and Buna-N O-Ring seals. The channel seal prevents blowout during connection and disconnection under pressure to 500 psi. The Buna-N O-Ring seal is a secondary seal eliminating fluid weepage.

\*Patent Number 5123446

### Physical Characteristics



Coupling Size	Maximum Operating Pressure (psi)	Minimum Burst Pressure (psi)	Vacuum (in./Hg.)	Rated Flow (gpm)	Air Inclusion (cc. max.)	Fluid Loss (cc. max.)
-06	3,000	9,000	28	10	.01	.02



FD49 Series	Coupling Size	Thread Size (P)	Dimensional Data				Part Number	Line Ref.
			A	B	①	②		
Male Half Female Pipe/Valved  	-06	3/8-18	2.62		1.00		FD49-1002-06-06	1
	-06	1/2-14	2.75		1.06		FD49-1002-08-06	2
								3
								4
								5
								6
								7
								8
Male Half Female SAE O-Ring/Valved  	-06	9/16-18	2.79		1.06		FD49-1004-06-06	9
	-06	3/4-16	2.75		1.00		FD49-1004-08-06	10
								11
								12
								13
								14
								15
								16
Male Half Male SAE O-Ring/Valved  	-06	9/16-18	2.99		1.00		FD49-1057-06-06	17
	-06	3/4-16	2.99		1.00		FD49-1057-08-06	18
								19
								20
								21
								22
								23
								24
Female Half Female Pipe/Valved  	-06	3/8-18	2.74	1.20	1.00	1.06	FD49-1001-06-06	25
	-06	1/2-14	2.85	1.20		1.06	FD49-1001-08-06	26
								27
								28
								29
								30
								31
								32
Female Half Female SAE O-Ring/Valved  	-06	3/4-16	2.82	1.20		1.06	FD49-1005-08-06	33
								34
								35
								36
								37
								38
								39
								40



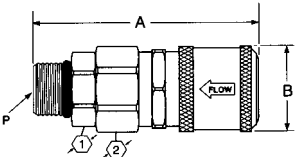
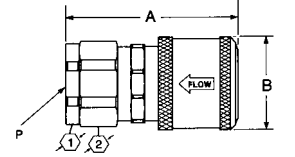

FD49 Series	Coupling Size	Thread Size (P)	Dimensional Data				Part Number	Line Ref.
			A	B	①	②		
Female Half Male SAE O-Ring/Valved  	-06	9/16-18	3.22	1.20	1.00	1.06	FD49-1014-06-06	1
	-06	3/4-16	3.28	1.20	1.00	1.06	FD49-1014-08-06	2
								3
								4
								5
								6
								7
								8
Female Half/Heavy Duty Sleeve Female Pipe/Valved  	-06	3/8-18	2.74	1.40	1.00	1.06	FD49-1200-06-06	9
	-06	1/2-14	2.85	1.40		1.06	FD49-1200-08-06	10
								11
								12
								13
								14
								15
								16
								17
<b>Accessories</b>								18
Dust Cover For Standard Coupling  	-06						FD49-1042-06	20
								22
								23
								24
								25
								26
								27
Dust Cover For Heavy Duty Coupling  	-06						FD49-1088-06	28
								30
								31
								32
								33
								34
								35



## 5100 Series/Low Spill—Connect Under Pressure

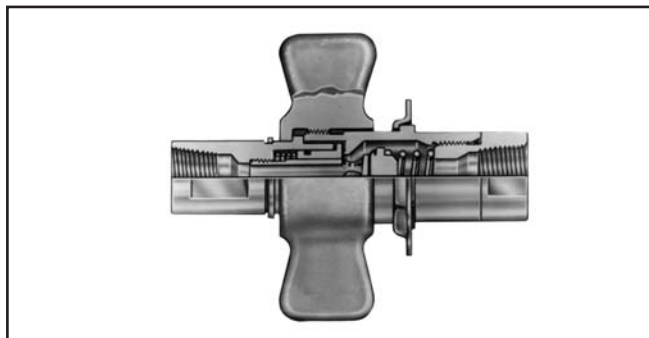
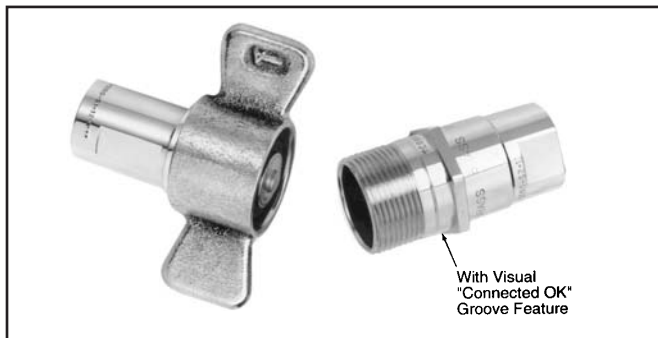

The 5100 Series brass coupling with steel tubular valve offers minimum air inclusion and fluid loss. Thread together latch provides connect under pressure capability and vibration resistance. It is not rated for continuous hydraulic impulse applications. (See FD86 on page 69.)

- Tubular valve construction for virtually no fluid loss during disconnection, reduces environmental and worker safety hazards.
- Low air inclusion during connection maintains system performance.
- Available with wing or hex nut configurations.
- Connect against pressure capability allows connecting of halves even when pressurized up to 500 psi.
- Steel flange available for accessible bulkhead mounting.
- Standard seal material – Buna-N.
- Standard body material – Brass with steel valving components, hex and wing nuts.

### Flow Data

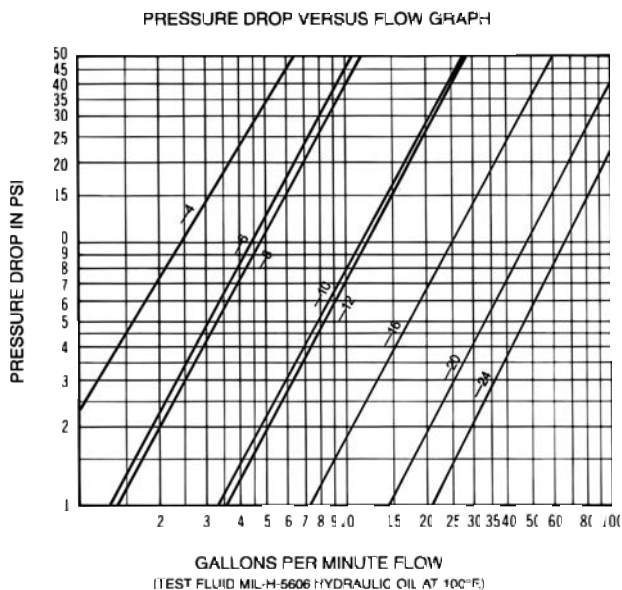

### Physical Characteristics

Coupling Dash Size	Coupling Interface Size	Maximum Operating Pressure* (psi connected)	Maximum Operating Pressure (psi disconnected)		Vacuum (in./Hg.)	Rated Flow (gpm)	Air Inclusion (cc max.)	Fluid Loss (cc max.)
			Male Half S2 and S4	Female Half S5				
-4	-4	3000	3000	3000	28	4	.03	.01
-6	-8	3000	3000	3000	28	7	.05	.06
-8	-8	3000	3000	3000	28	7	.05	.10
-10	-12	3000	3000	3000	28	18	.14	.10
-12	-12	3000	3000	3000	28	18	.34	.26
-16	-16	3000	3000	3000	28	40	.50	.35
-20	-20	2750	2500	2750	28	75	.68	.70
-24	-24	2500	2500	2000	28	100	.60	.94

\*Minimum burst pressure is equal to three times the maximum operating pressure. Not recommended for continuous hydraulic impulse applications at maximum operating pressures.



For component part number breakdown and service instructions, request bulletin JB41.

5100 Series	Coupling Size	Thread Size (P)	Dimensional Data				Part Number			Line Ref.
			A	B	①	②	Buna-N	Viton	EPR	
Male Half/Less Flange Female Pipe 	-4	1/8-27	1.88	.90	.69		5100-S2-4B			1
	-6	1/4-18	2.58	1.07	.94		5100-S2-6B			2
	-8	3/8-18	2.58	1.07	.94		5100-S2-8B			3
	-10	1/2-14	3.11	1.38	1.19		5100-S2-10B			4
	-12	3/4-14	3.11	1.38	1.19		5100-S2-12B			5
	-16	1-11 1/2	3.55	1.76	1.56		5100-S2-16B			6
	-20	1 1/4-11 1/2	3.71	2.10	1.88		5100-S2-20B			7
	-24	1 1/2-11 1/2	4.12	2.48	2.19		5100-S2-24B			8
Male Half/With Flange Female Pipe 	-4	1/8-27	1.88	.90	.94		5100-S4-4B			9
	-6	1/4-18	2.58	1.07	1.12		5100-S4-6B			10
	-8	3/8-18	2.58	1.07	1.12		5100-S4-8B			11
	-10	1/2-14	3.11	1.38	1.62		5100-S4-10B			12
	-12	3/4-14	3.11	1.38	1.62		5100-S4-12B			13
	-16	1-11 1/2	3.55	1.76	1.88		5100-S4-16B			14
	-20	1 1/4-11 1/2	3.71	2.10	2.12		5100-S4-20B			15
	-24	1 1/2-11 1/2	4.12	2.48	2.50		5100-S4-24B			16
Female Half/Wing Nut Female Pipe 	-4	1/8-27	1.97	3.03	.56		5100-S5-4B			17
	-6	1/4-18	2.37	3.44	.76		5100-S5-6B			18
	-8	3/8-18	2.37	3.44	.76		5100-S5-8B			19
	-10	1/2-14	3.09	4.06	1.16		5100-S5-10B			20
	-12	3/4-14	3.09	4.06	1.16		5100-S5-12B			21
	-16	1-11 1/2	3.67	4.38	1.44		5100-S5-16B			22
	-20	1 1/4-11 1/2	3.98	5.19	1.78		5100-S5-20B			23
	-24	1 1/2-11 1/2	4.02	5.31	2.00		5100-S5-24B			24
Female Half/Hex Nut Female Pipe 	-4	1/8-27	2.10	1.32	.56	1.19	5110-S5-4B			25
	-6	1/4-18	2.40	1.53	.76	1.38	5110-S5-6B			26
	-8	3/8-18	2.40	1.53	.76	1.38	5110-S5-8B			27
	-10	1/2-14	3.07	1.98	1.16	1.75	5110-S5-10B			28
	-12	3/4-14	3.07	1.98	1.16	1.75	5110-S5-12B			29
	-16	1-11 1/2	3.68	2.41	1.44	2.12	5110-S5-16B			30
	-20	1 1/4-11 1/2	4.00	2.81	1.78	2.50	5110-S5-20B			31
	-24	1 1/2-11 1/2	4.10	3.10	2.00	2.75	5110-S5-24B			32
Complete Coupling Less Flange/With Wing Nut/ Female Pipe 	-4	1/8-27	3.20				5101-4B			33
	-6	1/4-18	4.11				5101-6B			34
	-8	3/8-18	4.11				5101-8B			35
	-10	1/2-14	5.21				5101-10B			36
	-12	3/4-14	5.21				5101-12B			37
	-16	1-11 1/2	5.98				5101-16B			38
	-20	1 1/4-11 1/2	6.31				5101-20B			39
	-24	1 1/2-11 1/2	6.52				5101-24B			40
<b>Repair Kit</b> Each kit will repair male and female halves.	-4						FF098-04			41
	-6, -8						FF098-08			42
	-10, -12						FF098-12			43
	-16						FF098-16			44
	-20						FF098-20			45
	-24						FF098-24			46



For component part number breakdown and service instructions, request bulletin JB41.

5100 Series	Coupling Size	Thread Size (P)	Dimensional Data				Part Number			Line Ref.
			A	B			Buna-N	Viton	EPR	
Complete Coupling With Flange/With Wing Nut/ Female Pipe  	-4	1/8-27	3.24				5100-4B			1
	-6	1/4-18	4.11				5100-6B			2
	-8	3/8-18	4.11				5100-8B			3
	-10	1/2-14	5.21				5100-10B			4
	-12	3/4-14	5.21				5100-12B			5
	-16	1-11 1/2	5.99				5100-16B			6
	-20	1 1/4-11 1/2	6.33				5100-20B			7
	-24	1 1/2-11 1/2	6.54				5100-24B			8
Complete Coupling Less Flange/With Hex Nut/ Female Pipe  	-4	1/8-27	3.20				5111-4B			9
	-6	1/4-18	4.11				5111-6B			10
	-8	3/8-18	4.11				5111-8B			11
	-10	1/2-14	5.21				5111-10B			12
	-12	3/4-14	5.21				5111-12B			13
	-16	1-11 1/2	5.98				5111-16B			14
	-20	1 1/4-11 1/2	6.31				5111-20B			15
	-24	1 1/2-11 1/2	6.52				5111-24B			16
Complete Coupling With Flange/With Hex Nut/ Female Pipe  	-4	1/8-27	3.20				5110-4B			17
	-6	1/4-18	4.11				5110-6B			18
	-8	3/8-18	4.11				5110-8B			19
	-10	1/2-14	5.21				5110-10B			20
	-12	3/4-14	5.21				5110-12B			21
	-16	1-11 1/2	5.98				5110-16B			22
	-20	1 1/4-11 1/2	6.31				5110-20B			23
	-24	1 1/2-11 1/2	6.52				5110-24B			24
<b>Repair Kit</b> Each kit will repair male and female halves.	-4						FF098-04			25
	-6, -8						FF098-08			26
	-10, -12						FF098-12			27
	-16						FF098-16			28
	-20						FF098-20			29
	-24						FF098-24			30
<b>Accessories</b> Dust Cap with Chain**      Dust Plug with Chain**  	-4						Dust Cap with Chain	Dust Plug with Chain	6 Bolt Flange	31
	-4						5100-S7-5	5100-S9-5		32
	-6, -8						5100-S7-8	5100-S9-8		33
	-10, -12						5100-S7-12	5100-S9-12		34
	-16						5100-S7-16	5100-S9-16		35
	-20						5100-S7-20	5100-S9-20		36
	-24						5100-S7-24	5100-S9-24		37
										38
										39
	6 Bolt Flange*  	-4		.201	1.44					150-22-5
-6, -8			.201	1.69					150-22-8	41
-10, -12			.201	2.12					150-22-12	42
-16			.201	2.38					150-22-16	43
-20			.201	2.62					150-22-20	44
-24			.201	3.25					5100-22-24S	45

\*6 Bolt Flange-holes equally spaced. (See "A" for bolt hole diameter, and "B" for bolt circle diameter).

\*\*To order caps and plugs without chain, order cap by part number 5100-32-(size) and plug by part number 5100-41-(size).



## 5400 Series/Low Air Inclusion Refrigerant

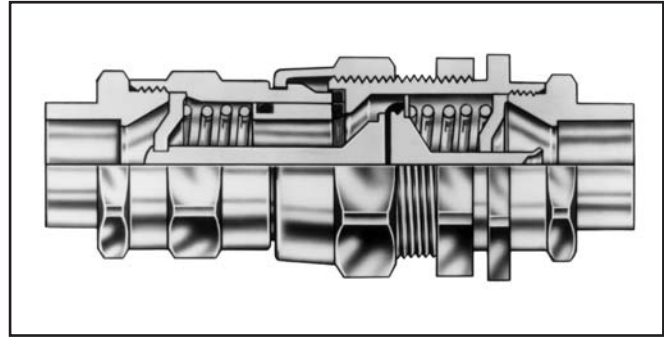
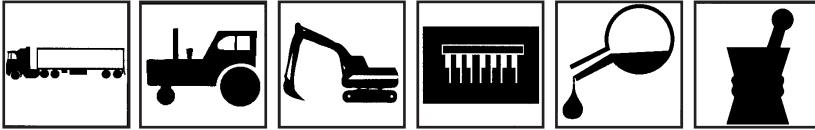

The 5400 Series is designed for air conditioning, refrigerant, gaseous and fluid transfer applications.

- Brazed or threaded end connections for versatility of installation on tubing or hose.
- Tubular valve construction for low fluid loss and air inclusion.
- Thread together design allows connection and disconnection against pressure.
- Lock washer and jam nut standard for optional bulk-head mounting.
- Standard seal material – Neoprene.
- Standard adapter material – Steel or Brass.
- Standard body material – Zinc plated steel.

### Flow Data

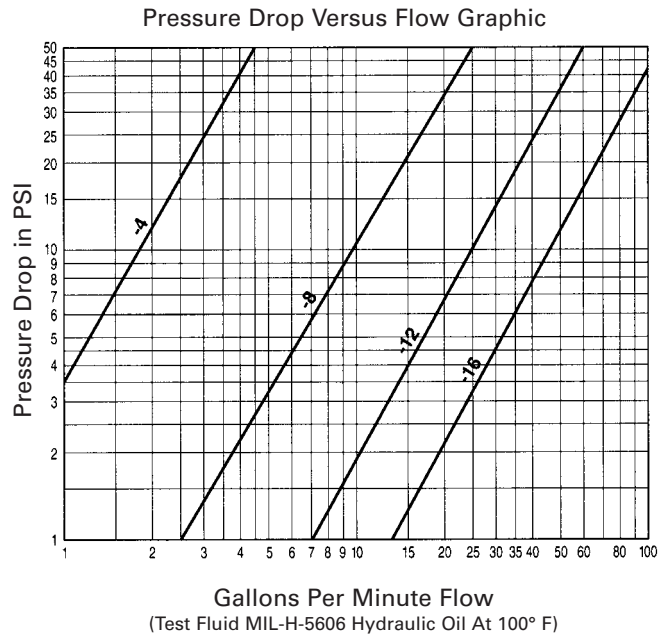

### Physical Characteristics

Coupling Dash Size	Maximum Operating Pressure (psi connected)	Minimum Burst Pressure (psi connected)	Maximum Operating Pressure (psi disconnected)		Vacuum (in./Hg.)	Rated Flow (gpm)	Air Inclusion (cc max.)	Fluid Loss (cc max.)
			Male Half	Female Half				
-4	3000	9000	2500	500	28	2	.10	.05
-8	1750	5200	1750	400	28	14	.10	.10
-12	700	2100	800	400	28	35	.30	.10
-16	700	2100	700	300	28	75	.50	.20



5400 Series	Coupling Size	Thread Size (P)	Tube O.D. Size	Dimensional Data					Part Number	Line Ref.
				A	B	①	②	③		
<b>Male Half No Adapter</b> 	-4			1.08	.83	.75			5400-S2-4	1
	-8			1.37	1.25	1.13			5400-S2-8	2
	-12			1.74	1.83	1.63			5400-S2-12	3
	-16			1.83	2.10	1.88			5400-S2-16	4
										5
										6
										7
										8
<b>Female Half No adapter</b> 	-4			1.13	.83	.63	.75		5400-S5-4	9
	-8			1.63	1.31	1.00	1.19		5400-S5-8	10
	-12			2.15	1.80	1.38	1.63		5400-S5-12	11
	-16			2.37	2.24	1.75	2.00		5400-S5-16	12
										13
										14
										15
										16
<b>Male Half SAE 37° (JIC)</b> 	-4	7/16-20		1.88	.83	.75		.63	5410-S17-4-4*	17
	-4	9/16-18		1.89	.83	.75		.63	5410-S17-6-4*	18
	-8	9/16-18		2.18	1.25	1.13		1.00	5410-S17-6-8*	19
	-8	3/4-16		2.28	1.25	1.13		1.00	5410-S17-8-8*	20
	-12	7/8-14		2.75	1.83	1.63		1.38	5410-S17-10-12*	21
	-12	1 1/16-12		2.86	1.83	1.63		1.38	5410-S17-12-12*	22
	-16	1 5/16-12		2.99	2.10	1.88		1.75	5410-S17-16-16*	23
										24
<b>Female Half SAE 37° (JIC)</b> 	-4	7/16-20		1.93	.83	.63	.75	.63	5410-S14-4-4*	25
	-4	9/16-18		1.94	.83	.63	.75	.63	5410-S14-6-4*	26
	-8	9/16-18		2.43	1.31	1.00	1.19	1.00	5410-S14-6-8*	27
	-8	3/4-16		2.53	1.31	1.00	1.19	1.00	5410-S14-8-8*	28
	-12	7/8-14		3.16	1.80	1.38	1.63	1.38	5410-S14-10-12*	29
	-12	1 1/16-12		3.27	1.80	1.38	1.63	1.38	5410-S14-12-12*	30
	-16	1 5/16-12		3.53	2.24	1.75	2.00	1.75	5410-S14-16-16*	31
										32
<b>Complete Coupling SAE 37° (JIC)</b> 	-4	7/16-20		3.54					5410-4-4*	33
	-4	9/16-18		3.56					5410-6-4*	34
	-8	9/16-18		4.23					5410-6-8*	35
	-8	3/4-16		4.44					5410-8-8*	36
	-12	7/8-14		5.33					5410-10-12*	37
	-12	1 1/16-12		5.54					5410-12-12*	38
	-16	1 5/16-12		5.89					5410-16-16*	39
										40
<b>Male Half Braze Tubing Adapter</b> 	-4		1/4	1.52	.83	.75		.63	5401-S17-4-4*	41
	-4		3/8	1.52	.83	.75		.63	5401-S17-6-4*	42
	-8		3/8	1.75	1.31	1.13		1.00	5401-S17-6-8*	43
	-8		1/2	1.75	1.31	1.13		1.00	5401-S17-8-8*	44
	-12		5/8	2.47	1.80	1.63		1.38	5401-S17-10-12*	45
	-12		3/4	2.47	1.80	1.63		1.38	5401-S17-12-12*	46
	-16		1	2.80	2.24	1.88		1.75	5401-S17-16-16*	47

\* Couplings must be ordered by components as shown on page 55



5400 Series	Coupling Size	Thread Size (P)	Tube O.D. Size	Dimensional Data					Part Number Neoprene	Line Ref.
				A	B	(1)	(2)	(3)		
<b>Female Half Braze Tubing Adapter</b> 	-4		1/4	1.57	.83	.63	.75	.63	5401-S14-4-4*	1
	-4		3/8	1.57	.83	.63	.75	.63	5401-S14-6-4*	2
	-8		3/8	2.00	1.31	1.00	1.19	1.00	5401-S14-6-8*	3
	-8		1/2	2.00	1.31	1.00	1.19	1.00	5401-S14-8-8*	4
	-12		5/8	2.88	1.80	1.38	1.63	1.38	5401-S14-10-12*	5
	-12		3/4	2.88	1.80	1.38	1.63	1.38	5401-S14-12-12*	6
	-16		1	3.34	2.24	1.75	2.00	1.75	5401-S14-16-16*	7
										8
<b>Accessories</b>				<b>Dust Cap with Gasket</b>				<b>Dust Plug with Gasket</b>		<b>9</b>
<b>Dust Cap</b> <b>Dust Plug</b> 	-4			5400-S6-4				5400-S8-4		10
	-8			5400-S6-8				5400-S8-8		11
	-12			5400-S6-12				5400-S8-12		12
	-16			5400-S6-16				5400-S8-16		13
										14
										15
										16
										17
<b>Adapter SAE 37° (JIC)</b> 				<b>O-Ring</b>		<b>Brass</b>		<b>Steel</b>		<b>18</b>
	-4	7/16-20	1/4	22546-12		202220-4-4B		202220-4-4S		19
	-4	9/16-18	3/8	22546-12		202220-6-4B		202220-6-4S		20
	-8	9/16-18	3/8	22546-17		202220-6-8B		202220-6-8S		21
	-8	3/4-16	1/2	22546-17		202220-8-8B		202220-8-8S		22
	-12	7/8-14	5/8	22546-23		202220-10-12B		202220-10-12S		23
	-12	1 1/16-12	3/4	22546-23		202220-12-12B		202220-12-12S		24
	-16	1 3/16-12	1	22546-28		202220-16-16B		202220-16-16S		25
<b>Adapter-Braze</b> <p>O-Ring Required</p>	-4	1/2-20	1/4	22546-12		202208-4-4B			26	
	-8	7/8-20	1/2	22546-17		202208-4-8B			27	
	-4	1/2-20	3/8	22546-12		202208-6-4B			28	
	-8	7/8-20	3/8	22546-17		202208-6-8B			29	
	-8	7/8-20	1/2	22546-17		202208-8-8B			30	
	-8	7/8-20	5/8	22546-17		202208-10-8B			31	
	-12	1 1/4-18	5/8	22546-23		202208-10-12B			32	
	-12	1 1/4-18	3/4	22546-23		202208-12-12B			33	
	-16	1 1/4-18	7/8	22546-23		202208-14-12B			34	
	-16	1 19/32-20	7/8	22546-28		202208-14-16B			35	
	-16	1 19/32-20	1	22546-28		202208-16-16B			36	
	-16	1 19/32-20	1 1/8	22546-28		202208-18-16B			37	
	-16	1 19/32-20	1 1/4	22546-28		202208-22-16B			38	
	<b>Hose Fitting SAE 100R5†</b> <p>O-Ring Required</p>			<b>Hose Size</b>	<b>D</b>					<b>39</b>
		-4	1/2-20	-4	.92	22546-12		487-4-4S		40
-4		1/2-20	-6	.96	22546-12		487-4-6S		41	
-8		7/8-20	-6	.96	22546-17		487-8-6S		42	
-8		7/8-20	-8	1.06	22546-17		487-8-8S		43	
-12		1 1/4-18	-10	1.07	22546-23		487-12-10S		44	
-16		1 19/32-20	-16	1.01	22546-28		487-16-16S		45	

† Additional dash styles available.

\* Couplings must be ordered by components as shown on page 55



For Assemblies, Order by Components as Shown by Base Number and dash (-) size below

Assembly Part Number	5400-S2		5400-S5		202208-Brass Braze-On		202220-Steel 37° SAE		22546	
	Female Half	Quantity	Male Half	Quantity	Adapter	Quantity	Adapter	Quantity	O-ring	Quantity
5401-S14-10-12			-12	1	-10 -12B	1			-23	1
5401-S14-10-8			-8	1	-10 -8B				-17	1
5401-S14-12-12			-12	1	-12 -12B	1			-23	1
5401-S14-16-16			-16	1	-16 -16B	1			-28	1
5401-S14-4-4			-4	1	-4 -4B	1			-12	1
5401-S14-6-4			-4	1	-6 -4B	1			-12	1
5401-S14-6-8			-8	1	-6 -8B	1			-17	1
5401-S14-8-8			-8	1	-8 -8B	1			-17	1
5401-S17-10-12	-12	1			-10 -12B	1			-23	1
5401-S17-10-8	-8	1			-10 -8B	1			-17	1
5401-S17-12-12	-12	1			-12 -12	1			-23	1
5401-S17-14-16	-16	1			-16 -16	1			-28	1
5401-S17-4-4	-4	1			-4 -4B	1			-17	1
5401-S17-6-4	-4	1			-6 -4B	1			-12	1
5401-S17-6-8	-8	1			-6 -8B	1			-17	1
5401-S17-8-8	-8	1			-8 -8B	1			-17	1
5410-12-12	-12	1	-12	1			-12 -12S	2	-23	2
5410-16-16	-16	1	-16	1			-16 -16S	2	-28	2
5410-4-4	-4	1	-4	1			-4 -4S	2	-12	2
5410-6-8	-8	1	-8	1			-6 -8S	2	-17	2
5410-8-8	-8	1	-8	1			-8 -8S	2	-17	2
5410-S14-10-12			-12	1			-10 -12S	1	-23	1
5410-S14-12-12			-12	1			-12 -12S	1	-23	1
5410-S14-16-16			-16	1			-16 -16S	1	-28	1
5410-S14-4-4			-4	1			-4 -4S	1	-12	1
5410-S14-6-4			-4	1			-6 -4S	1	-12	1
5410-S14-6-8			-8	1			-6 -8S	1	-17	1
5410-S14-8-8			-8	1			-8 -8S	1	-17	1
5410-S17-10-12	-12	1					-10 -12S	1	-23	1
5410-S17-12-12	-12	1					-12 -12S	1	-23	1
5410-S17-16-16	-16	1					-16 -16S	1	-28	1
5410-S17-4-4	-4	1					-4 -4S	1	-12	1
5410-S17-6-4	-4	1					-6 -4S	1	-12	1
5410-S17-6-8	-8	1					-6 -8S	1	-17	1
5410-S17-8-8	-8	1					-8 -8S	1	-17	1

Example, if a 5401-S14-10-12 is required, order as components,  
(1) 5400-S5-12, (1) 202208-10-12B Adapter and (1) 22546-23 O-Ring





## Assembly Instructions/Component Part Numbers

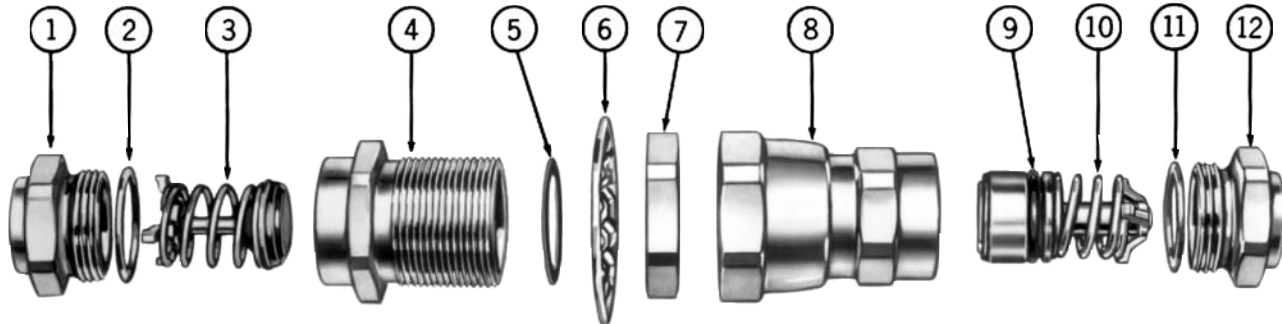

Typical Male Coupling Half (S2)

Typical Female Coupling Half (S5)

### Assembly Instructions

#### Steps:

- After tubing or hose has been connected to adapters ① and ⑫, install O-Rings ② and ⑪† on adapters. Be sure O-Rings are not twisted.
- Oil O-Rings ② and ⑪ liberally with system fluid to prevent them from scuffing and tearing when coupling body is threaded on adapter.
- S2 Half—Lubricate poppet face with system fluid. Insert poppet valve assembly ③ into body ④. Tighten body ④ on adapter ①. After body and adapter make metal-to-metal contact, tighten by rotating body ④  $1/8$ " with respect to adapter ① or torque per table value.  
S5 Half—Oil O-Ring ⑨† liberally with system fluid. Insert valve and sleeve assembly ⑩ into body ⑧. Tighten body ⑧ on adapter ⑫. After body and adapter make metal-to-metal contact, tighten by rotating body ⑧  $1/8$ " with respect to adapter ⑫ or torque per table value.
- Coupling Connection—Lubricate gasket seal ⑤ on 5400-S2 half with system fluid. Thread union nut ⑧ on 5400-S2 half. Tighten union nut to torque values shown in Table. Be sure S2 and S5 bodies do not rotate during connection.

### Bulkhead Mounting—S2 Half

Install lock washer ⑥ on S2 half. Insert S2 half through bulkhead, and tighten jam nut ⑦ so that lock washer teeth are fully compressed.

NOTE: Lock washer ⑥ must be between hex of S2 half and bulkhead.

### Maximum Bulkhead Thickness

Coupling Size	Lock Washer Installed	Lock Washer Not Used
-4	.206	.256
-8	.136	.203
-12	.232	.292
-16	.101	.161

### Torque Values

Recommended torque values in ft. lbs., are listed below.

Dash Size	Adapter to Body		S2 Half to S5 Half
	Braze Type or Aluminum	Non-braze Type Steel or Brass	
-4	6-8	12-15	10-12
-8	15-20	35-45	35-37
-12	35-40	45-55	45-47
-16	50-60	55-65	65-67

† IMPORTANT: Generous lubrication is required for all gaskets and O-rings. Use refrigeration oil only when used in refrigerant system.

### Component Part Numbers

Item No.	Dash Size →	-4	-8	-12	-16	Line Ref.
	O.D. Tube Size →	$1/4$ "- $3/8$ "	$1/4$ "- $5/8$ "	$5/8$ "- $7/8$ "	$7/8$ "- $1\ 3/8$ "	
<b>Typical Male Half</b>						
1	Tubing Adapter	202208-* -4	202208-* -8	202208-* -12	202208-* -16	2
2	O-Ring	22546-12	22546-17	22546-23	22546-28	3
3	Poppet Valve Assembly	5400-S20-4	5400-S20-8	5400-S20-12	5400-S20-16	4
4	Body	5400-17-4	5400-17-8	5400-17-12	5400-17-16	5
5	Gasket Seal	22008-4	22008-8	22008-12	22008-16	6
6	Lock Washer	5400-54-4S	5400-54-8S	5400-54-12S	5400-54-16S	7
7	Jam Nut	5400-53-4S	5400-53-8S	5400-53-12S	5400-53-16S	8
<b>Typical Female Half</b>						
8	Union Nut and Body Assembly	5400-S16-4	5400-S16-8	5400-S16-12	5400-S16-16	10
9	O-Ring	22546-10	22546-112	22546-116	22546-214	11
10	Valve and Sleeve Assembly	5400-S19-4	5400-S19-8	5400-S19-12	5400-S19-16	12
11	O-Ring	22546-12	22546-17	22546-23	22546-28	13
12	Tubing Adapter	202208-* -4	202208-* -8	202208-* -12	202208-* -16	14

\*Specify O.D. Tubing size of adapter required in 16th of an inch. Example: -4 coupling with  $3/8$ " O.D. tubing is  $6/16$  or -6. Part number is then 202208-6-4.



## 5600 Series/Industrial Interchange (Series A)

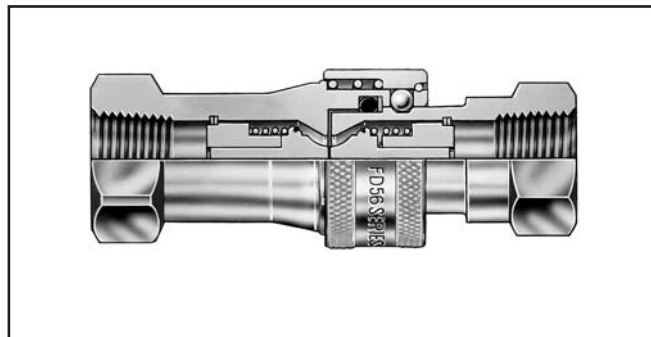
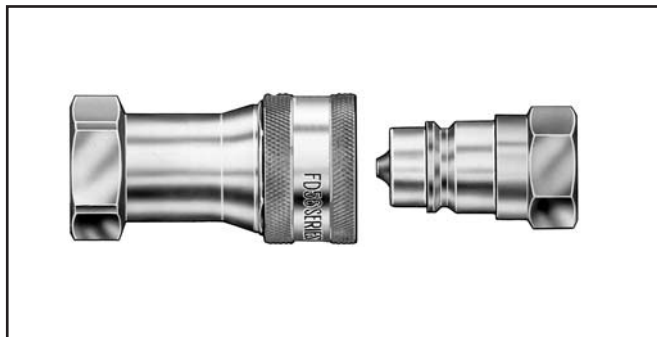

The 5600 Series general purpose coupling features a *PUSH-PULL™* latch and poppet valving in a low profile design. It is a favorite in North America and abroad.

- *PUSH-PULL™* ball latch design allows quick and easy connection and disconnection of fluid lines.
- Self-sealing poppet valve provides excellent high and low pressure sealing.
- Conforms dimensionally to ISO standard 7241/1 Series A.
- Streamlined valving provides minimum pressure drop.
- Standard seal materials – Buna-N, EPR and Viton.
- Standard body material – Zinc plated steel with Zinc poppet guides. (Brass poppet guide in -04 size.)

### Physical Characteristics

Coupling Size	Maximum Operating Pressure (psi)	Minimum Burst Pressure (psi)	Vacuum (in./Hg.)	Rated Flow (gpm)	Air Inclusion (cc. max.)	Fluid Loss (cc. max.)
-04	5,000	15,000	28	1	.50	.50
-06	4,000	12,000	28	6	1.5	1.3
-10	4,000	12,000	28	12	2.8	2.8
-12	4,000	12,000	28	28	10.0	8.2
-16	4,000	12,000	28	50	14.2	14.2

### Flow Data

Pressure Drop Versus Flow Graph

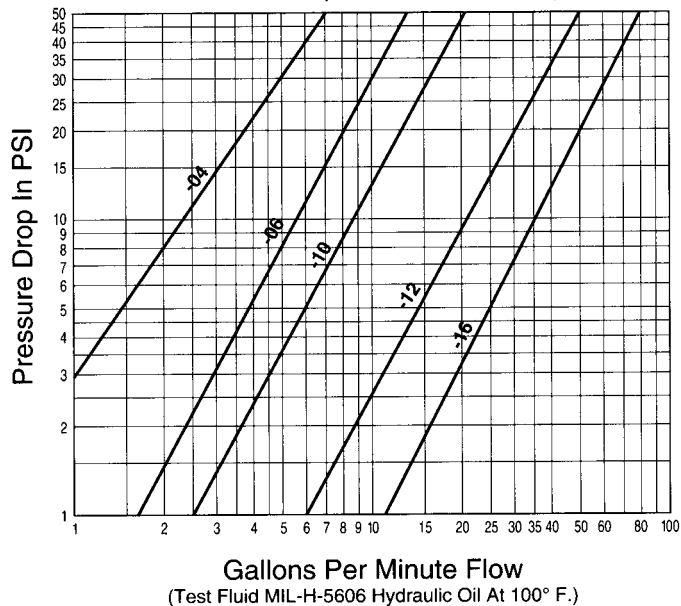



5600 Series	Coupling Size	Thread Size (P)	Dimensional Data			Part Number			Line Ref.
			A	B	$\phi$	Buna-N	Viton	EPR	
<b>Male Half Female Pipe/Valved</b> 	-04	1/8-27	1.17		.56	5602-2-4S	FD56-1062-02-04	5644-2-4S	1
	-04	1/4-18	1.24		.75	5602-4-4S	FD56-1062-04-04	5644-4-4S	2
	-06	3/8-18	1.40		.88	5602-6-6S	FD56-1062-06-06	5644-6-6S	3
	-10	1/2-14	1.89		1.06	5602-8-10S	FD56-1062-08-10	5644-8-10S	4
	-10	3/4-14	2.03		1.38	5602-12-10S	FD56-1062-12-10	5644-12-10S	5
	-12	3/4-14	2.28		1.38	5602-12-12S	FD56-1062-12-12	5644-12-12S	6
	-16	1-11 1/2	2.77		1.62	5602-16-16S	FD56-1062-16-16	5644-16-16S	7
<b>Female Half Female Pipe/Valved</b> 	-04	1/8-27	1.81	1.08	.88	5601-2-4S	FD56-1064-02-04	5643-2-4S	9
	-04	1/4-18	1.81	1.08	.88	5601-4-4S	FD56-1064-04-04	5643-4-4S	10
	-06	3/8-18	2.15	1.23	1.00	5601-6-6S	FD56-1064-06-06	5643-6-6S	11
	-10	1/2-14	2.61	1.50	1.19	5601-8-10S	FD56-1064-08-10	5643-8-10S	12
	-10	3/4-14	2.61	1.50	1.31	5601-12-10S	FD56-1064-12-10	5643-12-10S	13
	-12	3/4-14	3.25	1.81	1.50	5601-12-12S	FD56-1064-12-12	5643-12-12S	14
	-16	1-11 1/2	3.82	2.10	1.69	5601-16-16S	FD56-1064-16-16	5643-16-16S	15
<b>Female Half Female Pipe/Valved w/Sleeve Lock</b> 	-06	3/8-18	2.15	1.23	1.00	FD56-1239-06-06			16
	-10	1/2-14	2.61	1.50	1.19	FD56-1239-08-10			17
	-10	3/4-14	2.61	1.50	1.31	FD56-1239-10-10			18
	-12	3/4-14	3.25	1.81	1.50	FD56-1239-12-12			19
	-16	1-11 1/2	3.82	2.10	1.69	FD56-1239-16-16			20
									21
								22	
<b>Complete Coupling Female Pine/Valved</b> 	-04	1/8-27	2.42			5600-2-4S	FD56-1065-02-04	5642-2-4S	23
	-04	1/4-18	2.49			5600-4-4S	FD56-1065-04-04	5642-4-4S	24
	-06	3/8-18	2.80			5600-6-6S	FD56-1065-06-06	5642-6-6S	25
	-10	1/2-14	3.78			5600-8-10S	FD56-1065-08-10	5642-8-10S	26
	-10	3/4-14	4.06			5600-12-10S	FD56-1065-12-10	5642-12-10S	27
	-12	3/4-14	4.46			5600-12-12S	FD56-1065-12-12	5642-12-12S	28
	-16	1-11 1/2	5.54			5600-16-16S	FD56-1065-16-16	5642-16-16S	29
<b>Male Half/Female Pipe Non-Valved</b>  Will not operate with valved coupling halves. No valve actuator.	-04	1/8-27	1.17		.56	FD56-1037-02-04	FD56-1037-02-04	FD56-1037-02-04	30
	-04	1/4-18	1.24		.75	FD56-1037-04-04	FD56-1037-04-04	FD56-1037-04-04	31
	-06	3/8-18	1.40		.88	FD56-1037-06-06	FD56-1037-06-06	FD56-1037-06-06	32
	-10	1/2-14	1.89		1.06	FD56-1037-08-10	FD56-1037-08-10	FD56-1037-08-10	33
	-10	3/4-14	2.03		1.38	FD56-1037-12-10	FD56-1037-12-10	FD56-1037-12-10	34
	-12	3/4-14	2.28		1.38	FD56-1037-12-12	FD56-1037-12-12	FD56-1037-12-12	35
	-16	1-11 1/2	2.77		1.62	FD56-1037-16-16	FD56-1037-16-16	FD56-1037-16-16	36
<b>Female Half/Female Pipe Non-Valved</b>  Will not operate with valved coupling halves. No valve actuator.	-04	1/8-27	1.81	1.08	.88	FD56-1225-02-04	FD56-1207-02-04	FD56-1204-02-04	37
	-04	1/4-18	1.81	1.08	.88	FD56-1225-04-04	FD56-1207-04-04	FD56-1204-04-04	38
	-06	3/8-18	2.15	1.23	1.00	FD56-1225-06-06	FD56-1207-06-06	FD56-1204-06-06	39
	-10	1/2-14	2.61	1.50	1.19	FD56-1225-08-10	FD56-1207-08-10	FD56-1204-08-10	40
	-10	3/4-14	2.61	1.50	1.31	FD56-1225-12-10	FD56-1207-12-10	FD56-1204-12-10	41
	-12	3/4-14	3.25	1.81	1.50	FD56-1225-12-12	FD56-1207-12-12	FD56-1204-12-12	42
	-16	1-11 1/2	3.82	2.10	1.69	FD56-1225-16-16	FD56-1207-16-16	FD56-1204-16-16	43
<b>Repair Kit</b> Each kit will repair one male or female half.	-04					FF082-04†	FF092-04†	FF093-04†	44
	-06					FF082-06	FF092-06	FF093-06	45
	-10					FF082-10	FF092-10	FF093-10	46
	-12					FF082-12	FF092-12	FF093-12	47
	-16					FF082-16	FF092-16	FF093-16	48

† This size repair kit contains an interface seal and back-up ring.







5600 Series	Coupling Size	Thread Size (P)	Dimensional Data			Part Number			Line Ref.
			A	B		Buna-N	Viton	EPR	
Complete Coupling/Non-Valved Female Pipe  	-04	1/8-27	2.42			FD56-1226-02-04	FD56-1208-02-04	FD56-1205-02-04	1
	-04	1/4-18	2.49			FD56-1226-04-04	FD56-1208-04-04	FD56-1205-04-04	2
	-06	3/8-18	2.80			FD56-1226-06-06	FD56-1208-06-06	FD56-1205-06-06	3
	-10	1/2-14	3.78			FD56-1226-08-10	FD56-1208-08-10	FD56-1205-08-10	4
	-10	3/4-14	4.06			FD56-1226-12-10	FD56-1208-12-10	FD56-1205-12-10	5
	-12	3/4-14	4.46			FD56-1226-12-12	FD56-1208-12-12	FD56-1205-12-12	6
	-16	1-11 1/2	5.54			FD56-1226-16-16	FD56-1208-16-16	FD56-1205-16-16	7
									8
Male Half/Female Pipe Pusher Style Valving  <p>Incorporates a pusher device to open mating valved coupling halves.</p>	-04	1/8-27	1.17		.56	FD56-1125-02-04	FD56-1125-02-04	FD56-1125-02-04	9
	-04	1/4-18	1.24		.75	FD56-1125-04-04	FD56-1125-04-04	FD56-1125-04-04	10
	-06	3/8-18	1.40		.88	FD56-1125-06-06	FD56-1125-06-06	FD56-1125-06-06	11
	-10	1/2-14	1.89		1.06	FD56-1125-08-10	FD56-1125-08-10	FD56-1125-08-10	12
	-10	3/4-14	2.03		1.38	FD56-1125-12-10	FD56-1125-12-10	FD56-1125-12-10	13
	-12	3/4-14	2.28		1.38	FD56-1125-12-12	FD56-1125-12-12	FD56-1125-12-12	14
	-16	1-11 1/2	2.77		1.62	FD56-1125-16-16	FD56-1125-16-16	FD56-1125-16-16	15
									16
Female Half/Female Pipe Pusher Style Valving  <p>Incorporates a pusher device to open mating valved coupling halves.</p>	-04	1/8-27	1.81	1.08	.88	FD56-1123-02-04	FD56-1201-02-04	FD56-1196-02-04	17
	-04	1/4-18	1.81	1.08	.88	FD56-1123-04-04	FD56-1201-04-04	FD56-1196-04-04	18
	-06	3/8-18	2.15	1.23	1.00	FD56-1123-06-06	FD56-1201-06-06	FD56-1196-06-06	19
	-10	1/2-14	2.61	1.50	1.19	FD56-1123-08-10	FD56-1201-08-10	FD56-1196-08-10	20
	-10	3/4-14	2.61	1.50	1.31	FD56-1123-12-10	FD56-1201-12-10	FD56-1196-12-10	21
	-12	3/4-14	3.25	1.81	1.50	FD56-1123-12-12	FD56-1201-12-12	FD56-1196-12-12	22
	-16	1-11 1/2	3.82	2.10	1.69	FD56-1123-16-16	FD56-1201-16-16	FD56-1196-16-16	23
									24
Female Half/Female Pipe Connect Under Pressure Style  	-10	1/2-14	2.88	1.52	1.06	5651-8-10S	FD56-1070-08-10	565007-8-10S	25
	-10	3/4-14	3.30	1.22	1.25	5651-12-10S	FD56-1070-12-10	565007-12-10S	26
									27
									28
									29
									30
									31
									32
Complete Coupling/Female Pipe Connect Under Pressure Style  	-10	1/2-14	3.89			5650-8-10S	FD56-1071-08-10	565006-8-10S	33
	-10	3/4-14	4.45			5650-12-10S	FD56-1071-12-10	565006-12-10S	34
									35
									36
									37
									38
									39
									40
<b>Repair Kit</b>									
Each kit will repair one male or female half.									
	-04					FF082-04†	FF092-04†	FF093-04†	42
	-06					FF082-06	FF092-06	FF093-06	43
	-10					FF082-10	FF092-10	FF093-10	44
	-12					FF082-12	FF092-12	FF093-12	45
	-16					FF082-16	FF092-16	FF093-16	46

† This size repair kit contains an interface seal and back-up ring.

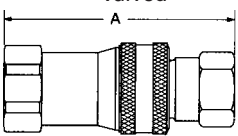
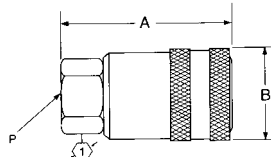
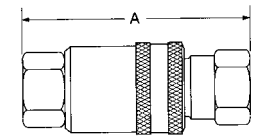

5600 Series	Coupling Size	Thread Size (P)	Dimensional Data			Part Number			Line Ref.
			A	B	$\phi$	Buna-N	Viton	EPR	
<b>Male Half</b> <b>Female SAE O-Ring/Valved</b> 	-04	7/16-20	1.28		.62	5610-4-4S	FD56-1072-04-04	560078-4-4S	1
	-06	9/16-18	1.50		.88	5610-6-6S	FD56-1072-06-06	560078-6-6S	2
	-10	3/4-16	2.03		1.06	5610-8-10S	FD56-1072-08-10	560078-8-10S	3
	-10	7/8-14	2.08		1.12	5610-10-10S	FD56-1072-10-10	560078-10-10S	4
	-10	1 1/16-12	2.26		1.38	5610-12-10S	FD56-1072-12-10	560078-12-10S	5
	-12	1 1/16-12	2.55		1.38	5610-12-12S	FD56-1072-12-12	560078-12-12S	6
	-16	1 5/16-12	3.10		1.62	5610-16-16S	FD56-1072-16-16	560078-16-16S	7
<b>Female Half</b> <b>Female SAE O-Ring/Valved</b> 	-04	7/16-20	1.81	1.08	.88	5608-4-4S	FD56-1074-04-04	FD56-1012-04-04	9
	-06	9/16-18	2.11	1.27	1.00	5608-6-6S	FD56-1074-06-06	FD56-1012-06-06	10
	-10	3/4-16	2.76	1.52	1.19	5608-8-10S	FD56-1074-08-10	FD56-1012-08-10	11
	-10	7/8-14	2.81	1.52	1.19	5608-10-10S	FD56-1074-10-10	FD56-1012-10-10	12
	-10	1 1/16-12	3.00	1.52	1.31	5608-12-10S	FD56-1074-12-10	FD56-1012-12-10	13
	-12	1 1/16-12	3.25	1.84	1.50	5608-12-12S	FD56-1074-12-12	FD56-1012-12-12	14
	-16	1 5/16-12	3.83	2.15	1.88	5608-16-16S	FD56-1074-16-16	FD56-1012-16-16	15
<b>Female Half Female SAE O-Ring/Valved w/Sleeve Lock</b> 	-06	9/16-18	2.11	1.27	1.00	FD56-1270-06-06			16
	-10	3/4-16	2.76	1.52	1.19	FD56-1270-08-10			17
	-12	1 1/16-12	3.25	1.84	1.50	FD56-1270-12-12			18
	-16	1 5/16-12	3.83	2.15	1.88	FD56-1270-16-16			19
									20
									21
<b>Complete Coupling</b> <b>Female SAE O-Ring/Valved</b> 	-04	7/16-20	2.53			5606-4-4S	FD56-1075-04-04	FD56-1009-04-04	23
	-06	9/16-18	2.84			5606-6-6S	FD56-1075-06-06	FD56-1009-06-06	24
	-10	3/4-16	3.78			5606-8-10S	FD56-1075-08-10	FD56-1009-08-10	25
	-10	7/8-14	3.88			5606-10-10S	FD56-1075-10-10	FD56-1009-10-10	26
	-10	1 1/16-12	4.24			5606-12-10S	FD56-1075-12-10	FD56-1009-12-10	27
	-12	1 1/16-12	4.46			5606-12-12S	FD56-1075-12-12	FD56-1009-12-12	28
	-16	1 5/16-12	5.54			5606-16-16S	FD56-1075-16-16	FD56-1009-16-16	29
<b>Male Half</b> <b>Female SAE O-Ring/Non-Valved</b>  Will not operate with valved coupling halves. No valve actuator.	-04	7/16-20	1.21	.72	.62	FD56-1221-04-04	FD56-1221-04-04	FD56-1221-04-04	30
	-06	9/16-18	1.42	.73	.88	FD56-1221-06-06	FD56-1221-06-06	FD56-1221-06-06	31
	-10	3/4-16	1.89	1.02	1.06	FD56-1221-08-10	FD56-1221-08-10	FD56-1221-08-10	32
	-10	7/8-14	1.94	1.07	1.12	FD56-1221-10-10	FD56-1221-10-10	FD56-1221-10-10	33
	-10	1 1/16-12	2.12	1.24	1.38	FD56-1221-12-10	FD56-1221-12-10	FD56-1221-12-10	34
	-12	1 1/16-12	2.28	1.21	1.38	FD56-1221-12-12	FD56-1221-12-12	FD56-1221-12-12	35
	-16	1 5/16-12	2.77	1.45	1.62	FD56-1221-16-16	FD56-1221-16-16	FD56-1221-16-16	36
<b>Female Half</b> <b>Female SAE O-Ring/Non-Valved</b>  Will not operate with valved coupling valves. No valve actuator.	-04	7/16-20	1.81	1.08	.88	5691-4-4S	FD56-1233-04-04	FD56-1209-04-04	37
	-06	9/16-18	2.11	1.27	1.06	5691-6-6S	FD56-1233-06-06	FD56-1209-06-06	38
	-10	3/4-16	2.76	1.52	1.25	5691-8-10S	FD56-1233-08-10	FD56-1209-08-10	39
	-10	7/8-14	2.81	1.52	1.25	5691-10-10S	FD56-1233-10-10	FD56-1209-10-10	40
	-10	1 1/16-12	3.00	1.52	1.38	5691-12-10S	FD56-1233-12-10	FD56-1209-12-10	41
	-12	1 1/16-12	3.25	1.84	1.50	5691-12-12S	FD56-1233-12-12	FD56-1209-12-12	42
	-16	1 5/16-12	4.09	2.15	1.88	5691-16-16S	FD56-1233-16-16	FD56-1209-16-16	43
<b>Repair Kit</b> Each kit will repair one male or female half. † This size repair kit contains an interface seal and back-up ring.	-04					FF082-04†	FF092-04†	FF093-04†	44
	-06					FF082-06	FF092-06	FF093-06	45
	-10					FF082-10	FF092-10	FF093-10	46
	-12					FF082-12	FF092-12	FF093-12	47
	-16					FF082-16	FF092-16	FF093-16	48



5600 Series	Coupling Size	Thread Size (P)	Dimensional Data			Part Number			Line Ref.
			A	B	$\gamma$	Buna-N	Viton	EPR	
<b>Complete Coupling Female SAE O-Ring/Non-Valved</b>  Will not operate with valved coupling halves.	-04	7/16-20	2.53			5690-4-4S	FD56-1234-04-04	FD56-1210-04-04	1
	-06	9/16-18	2.84			5690-6-6S	FD56-1234-06-06	FD56-1210-06-06	2
	-10	3/4-16	3.78			5690-8-10	FD56-1234-08-10	FD56-1210-08-10	3
	-10	7/8-14	3.88			5690-10-10S	FD56-1234-10-10	FD56-1210-10-10	4
	-10	1 1/16-12	4.24			5690-12-10S	FD56-1234-12-10	FD56-1210-12-10	5
	-12	1 1/16-12	4.46			5690-12-12S	FD56-1234-12-12	FD56-1210-12-12	6
	-16	1 5/16-12	5.54			5690-16-16S	FD56-1234-16-16	FD56-1210-16-16	7
									8
<b>Female Half/Female SAE O-Ring Connect Under Pressure</b> 	-10	3/4-16	2.88	1.52	1.06	5668-8-10S	FD56-1081-8-10	565015-8-10S	9
	-10	7/8-14	3.19	1.52	1.12	5668-10-10S	FD56-1081-10-10	565015-10-10S	10
	-10	1 1/16-12	3.38	1.52	1.38	5668-12-10S	FD56-1081-12-10	565015-12-10S	11
									12
									13
									14
								15	
								16	
<b>Complete Coupling/Female SAE O-Ring Connect Under Pressure</b> 	-10	3/4-16	3.88			5667-8-10S	FD56-1082-8-10	565014-8-10S	17
	-10	7/8-14	4.25			5667-10-10S	FD56-1082-10-10	565014-10-10S	18
	-10	1 1/16-12	4.62			5667-12-10S	FD56-1082-12-10	565014-12-10S	19
									20
									21
									22
									23
									24
								25	
<b>Repair Kit</b> Each kit will repair one male or female half.  †This size repair kit contains an inter-face seal and back-up ring.	-04					FF082-04†	FF092-04†	FF093-04†	26
	-06					FF082-06	FF092-06	FF093-06	27
	-10					FF082-10	FF092-10	FF093-10	28
	-12					FF082-12	FF092-12	FF093-12	29
	-16					FF082-16	FF092-16	FF093-16	30
								31	
<b>Accessories</b> <b>Dust Cap</b> 	-04					5657-4			32
	-06					5657-6			33
	-10					5657-10			34
	-12					5657-12			35
	-16					5657-16			36
<b>Dust Plug</b> 	-4					5659-4			37
	-6					5659-6			38
	-10					5659-10			39
	-12					5659-12			40
	-16					5659-16			41
<b>Break Away Frame</b> 	-10					5603			42
									43
									44
									45
								46	



## FD69 Series/Arc Latch™ – High Pressure Water Blast (10,000 psi)

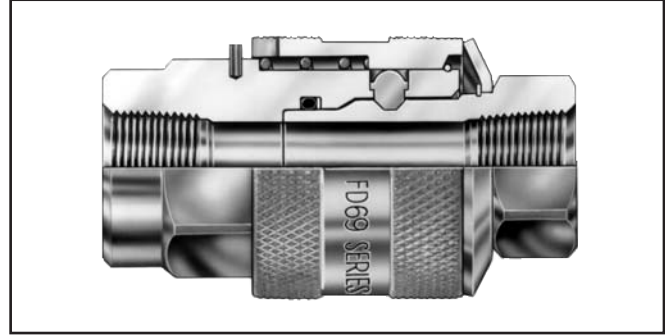
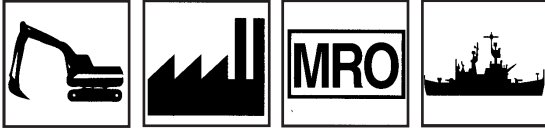

The FD69 Series “Arc Latch™” design has a greater surface contact area for long service life in rugged high-pressure and water blast applications. The maximum operating pressure is 10,000 psi with 40,000 psi minimum burst pressure.

- Safety sleeve lock guards against accidental disconnection.
- Smooth bore “straight through” design for high flow.
- Heavy duty back-up ring to prevent O-Ring extrusion.
- Available in plated steel and stainless steel for added corrosion resistance.
- Standard seal material – Buna-N.
- Standard body material – Zinc plated steel, Stainless steel.

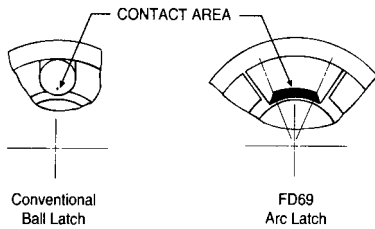

### Flow Data

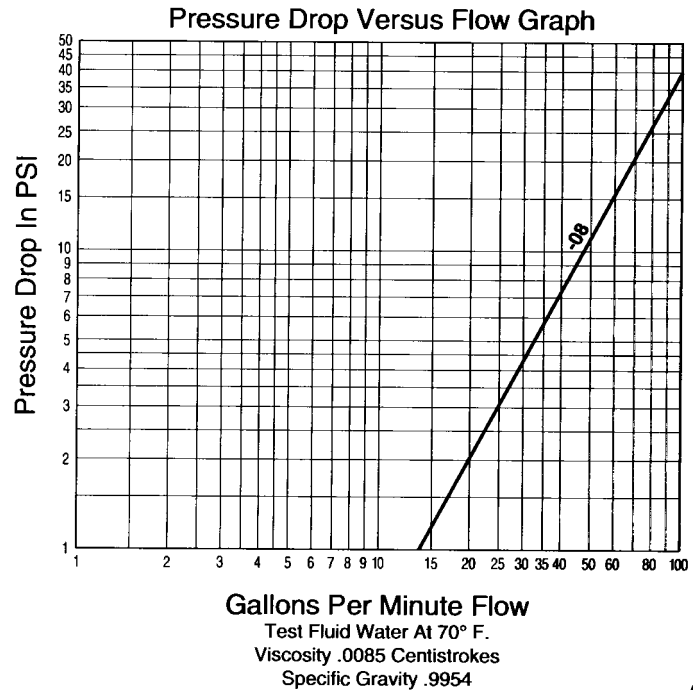

### Physical Characteristics

Coupling Dash Size	Maximum Operating Pressure (psi)	Minimum Burst Pressure (psi)	Vacuum (in./Hg.)	Rated Flow (gpm)	Air Inclusion (cc. max.)	Fluid Loss (cc. max)
-08	10,000	40,000	28	45	-	-



FD69 Series	Coupling Size	Thread Size (P)	Thread Size (P <sub>1</sub> )	Dimensional Data			Part Number			Line Ref.
				A	B		Buna-N	Viton	EPR	
<b>Male Half/Female Pipe</b> 	<b>Steel</b>									<b>1</b>
	-08	3/8-18		1.85	1.64	1.00	FD69-1002-06-08	FD69-1002-06-08	FD69-1002-06-08	<b>2</b>
	-08	1/2-14		2.34	1.64	1.12	FD69-1002-08-08	FD69-1002-08-08	FD69-1002-08-08	<b>3</b>
										<b>4</b>
	<b>Stainless Steel</b>									<b>5</b>
	-08	1/2-14		2.34	1.64	1.12	FD69-1012-08-08	FD69-1012-08-08	FD69-1012-08-08	<b>6</b>
										<b>7</b>
										<b>8</b>
										<b>9</b>
	<b>Female Half/Female Pipe</b> 	<b>Steel</b>								
-08		3/8-18		2.13	1.62	1.25	FD69-1001-06-08	FD69-1026-06-08	FD69-1028-06-08	<b>11</b>
-08		1/2-14		2.13	1.62	1.25	FD69-1001-08-08	FD69-1026-08-08	FD69-1028-08-08	<b>12</b>
										<b>13</b>
<b>Stainless Steel</b>									<b>14</b>	
-08		1/2-14		2.13	1.62	1.25	FD69-1011-08-08			<b>15</b>
										<b>16</b>
										<b>17</b>
<b>Complete Coupling Female Pipe</b> 	<b>Steel</b>									<b>18</b>
	-08	1/2-14	1/2-14	3.43			FD69-1000-080808	FD69-1027-080808	FD69-1029-080808	<b>19</b>
	-08	1/2-14	3/8-18	3.43			FD69-1000-080806	FD69-1027-080806	FD69-1029-080806	<b>20</b>
	-08	3/8-18	1/2-14	2.94			FD69-1000-060808	FD69-1027-060808	FD69-1029-060808	<b>21</b>
	-08	3/8-18	3/8-18	2.94			FD69-1000-060806	FD69-1027-060806	FD69-1029-060806	<b>22</b>
	<b>Stainless Steel</b>									<b>23</b>
	-08	1/2-14	1/2-14	3.43			FD69-1010-080808			<b>24</b>
										<b>25</b>
										<b>26</b>
	<b>Repair Kit</b>	<b>Female Interface Seal Kit</b>								
-08							FF10166			<b>26</b>





## FD71 Series/ Push-to-Connect Farm

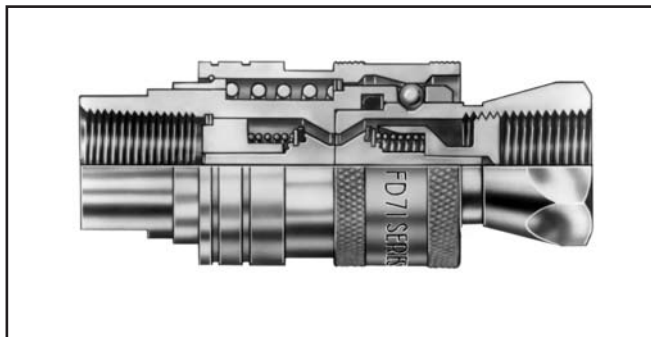
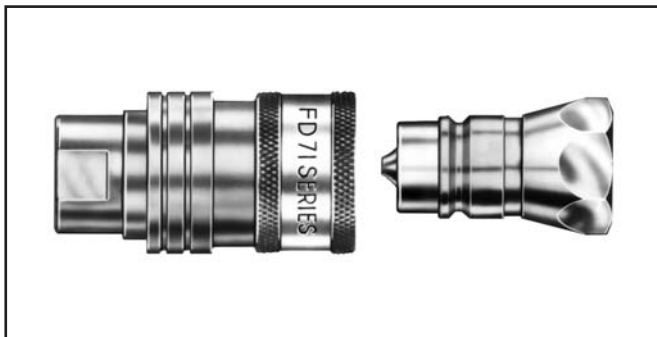
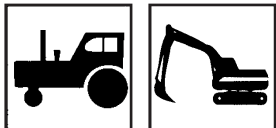

The FD71 Series coupling is designed to interchange with male tips made to ISO 5675 specifications. It features one hand push-to-connect latching. The maximum operating pressure is 3,000 psi.

- Self-sealing poppet valve construction provides reliable leak-free service.
- Push-to-connect for one-hand operation when sleeve is mounted.
- Retaining ring groove on female half for bulkhead and break-away frame mounting.
- Standard seal material – Buna-N.
- Standard body material – Zinc plated steel with Zinc poppet guide.

### Flow Data

Pressure Drop versus Flow Graph

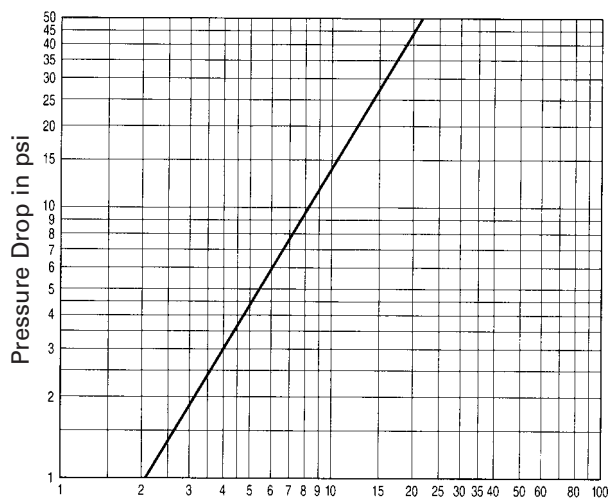

Gallons per Minute Flow  
(Test Fluid MIL-H-5606 Hydraulic Oil at 100°F)

### Physical Characteristics

Coupling Size	Maximum Operating Pressure (psi)	Minimum Burst Pressure (psi)	Vacuum (in./Hg.)	Rated Flow (gpm)	Air Inclusion (cc. max.)	Fluid Loss (cc. max.)
-10	3,000	12,000	28	16	2.8	2.8



FD71 Series	Coupling Size	Thread Size (P)	Dimensional Data						Part Number	Line Ref.
			A	B	C	D	E	Y		
Male Half Female Pipe/Valved 	-10	1/2-14	2.05					1.06	FD76-1002-08-10	1
										2
										3
										4
										5
										6
										7
										8
Female Half Female Pipe/Valved 	-10	1/2-14	2.74	1.52	1.50	1.41	.20	1.00	FD71-1001-08-10	9
										10
										11
										12
										13
										14
										15
										16
<b>Accessories</b>										17
Dust Cap 	-10								5657-10	18
										19
										20
										21
										22
										23
										24
										25
Dust Plug 	-10								5659-10	25
										26
										27
										28
										29
										30
										31
										32
Break Away Frame 	-10								5603	33
										34
										35
										36
										37
										38
										39
										40



## FD72 Series/Connect Under Pressure—Farm

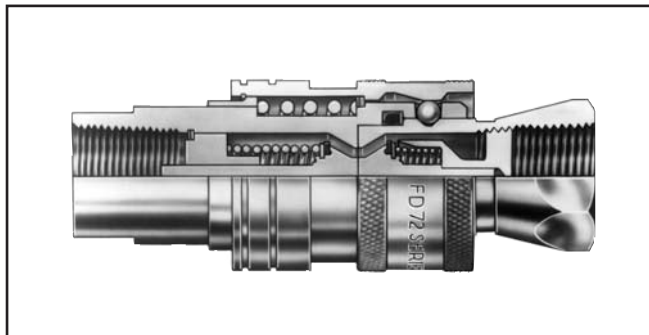
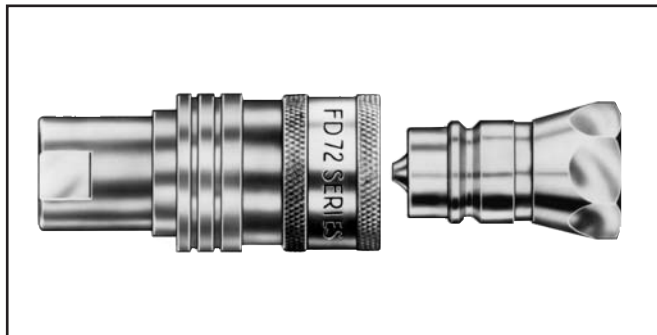

The FD72 Series coupling incorporates special valving allowing connection to a male half under pressure (FD76 Series male). The maximum operating pressure is 3,000 psi.

- Over travel, self-sealing poppet valve construction for connecting to a pressurized male tip. Requires that the tractor control valve be actuated to open the flow path and to equalize the pressure.
- Push-to-connect for one-hand operation when sleeve is mounted.
- Interchanges with ISO 5675 male tips.
- Retaining ring groove on female half for bulkhead and breakaway frame mounting.
- Standard seal material – Buna-N.
- Standard body material – Zinc plated steel with zinc poppet guide.

### Physical Characteristics

Coupling Size	Maximum Operating Pressure (psi)	Minimum Burst Pressure (psi)	Vacuum (in. Hg.)	Rated Flow (gpm)	Air Inclusion (cc. max.)	Fluid Loss (cc. max.)
-10	3,000	12,000	28	16	2.8	2.8

### Flow Data

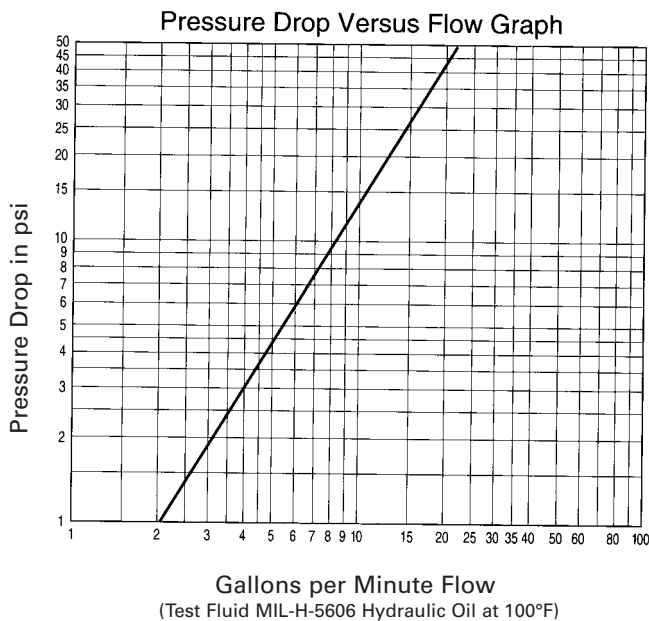



FD72 Series	Coupling Size	Thread Size (P)	Dimensional Data							Part Number	Line Ref.
			A	B	C	D	E		Buna-N		
<b>Male Half Female Pipe/Valved</b> 	-10	1/2-14	2.05						1.06	FD76-1002-08-10	1
											2
											3
											4
											5
											6
											7
											8
<b>Female Half Female Pipe/Valved</b> 	-10	1/2-14	3.17	1.52	1.50	1.41	.20	1.00		FD72-1001-08-10	9
											10
											11
											13
											14
											15
											16
											17
<b>Accessories</b>											18
<b>Dust Cap</b> 	-10									5657-10	19
											20
											21
											22
											23
											24
<b>Dust Plug</b> 	-10									5659-10	25
											26
											27
											28
											29
											30
											31
											32
<b>Break Away Frame</b> 	-10									5603	33
											34
											35
											36
											37
											38
											39
										40	



# FD70 & FD76 Series/Male Tip—Farm

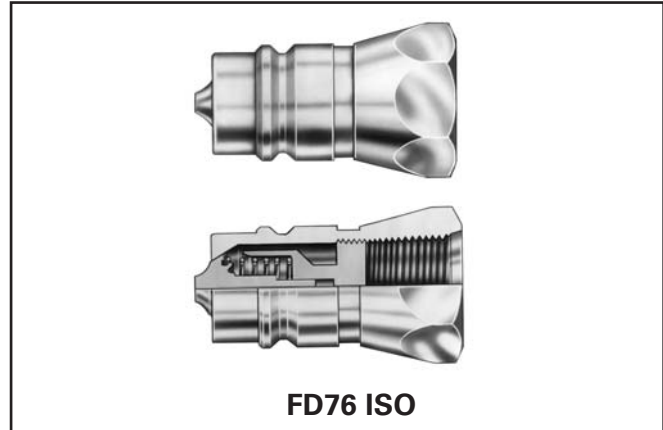
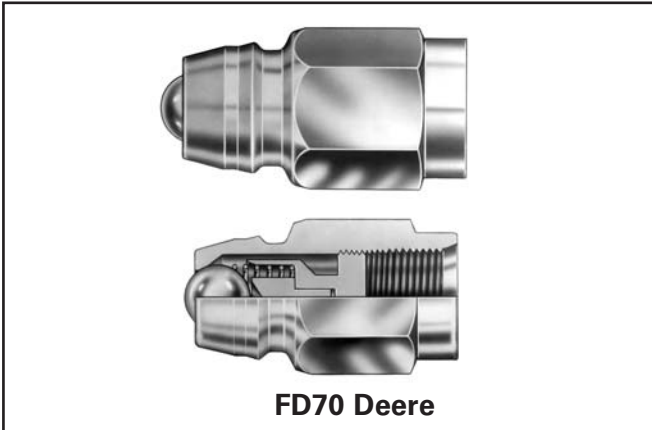

● Designed to connect with female couplings on most older style John Deere farm equipment.

● Interchanges with ISO 5675 used on most farm tractors found throughout North America and abroad.

FD70 & FD76 Series	Coupling Size	Thread Size (P)	Dimensional Data			Part Number Buna-N	Line Ref.
			A	B			
Deere Male Half Female SAE O-Ring/Ball Valve 	-10	3/4-16	1.96		1.00	FD70-1010-08-10	1
							2
							3
							4
							5
							6
							7
							8
ISO Male Half Female Pipe/Poppet Valve 	-10	1/2-14	2.05		1.06	FD76-1002-08-10	9
							10
							11
							12
							13
							14
							15
							16
ISO Male Half Female SAE O-Ring/Poppet Valve 	-10	3/4-16	2.05		1.00	FD76-1010-08-10	17
							18
							19
							20
							21
							22
							23
							24



## FD86 Series/5,000 PSI DryBreak—High Impulse

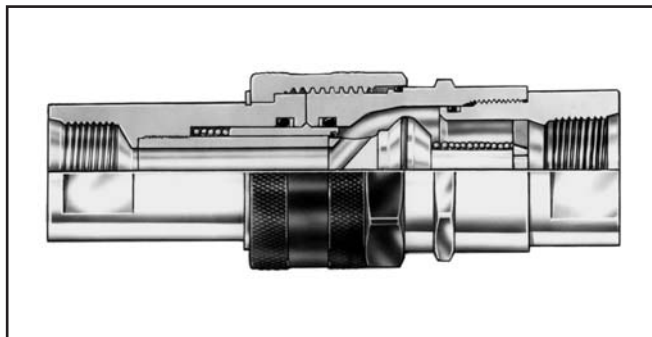
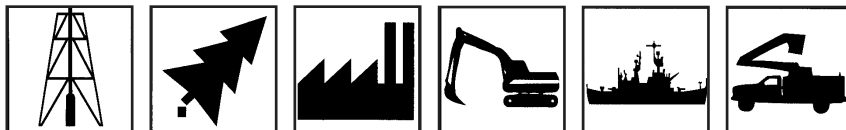

The FD86 Series is a thread together steel coupling offering dry break and high impulse technology and capabilities. The maximum operating pressure is 5,000 psi.

- Tubular valve and sleeve construction for low fluid loss and air inclusion.
- Thread together design using wing or hex nut allows connection and disconnection against pressures up to 750 psi.
- Teflon\* back-up rings along with secondary metal-to-metal sealing contact provides high impulse capability up to 5,000 psi operating pressure.
- Acme threads prevent galling and provide ease of connection.
- Metal-to-metal sealing withstands +2,000°F for ten minutes with no fluid loss (requirement in California for oil field blow-out preventers).
- Steel flange available for bulkhead mounting.
- Standard seal material – Buna-N.
- Standard body material – Zinc plated steel.

\*Teflon is a registered trademark of Dupont.

### Flow Data

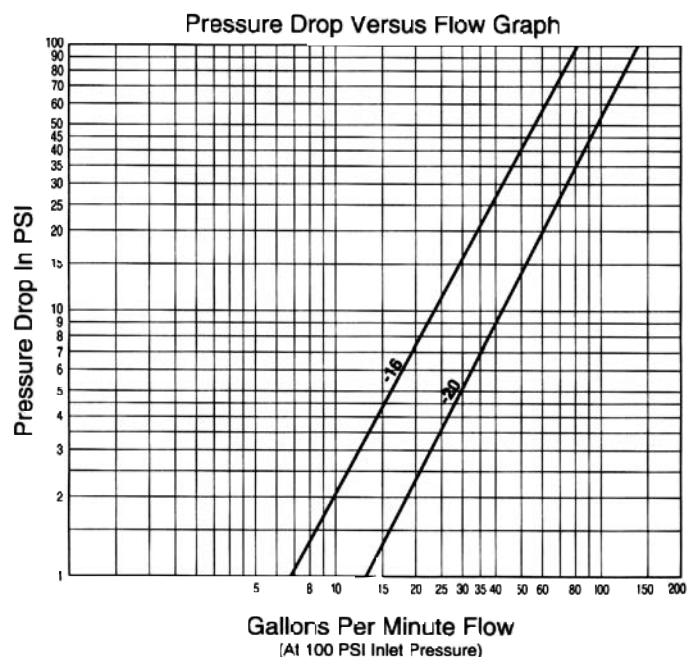

### Physical Characteristics

Coupling Size	Maximum Operating Pressure (psi)	Minimum Burst Pressure (psi)	Vacuum (in./Hg.)	Rated Flow (gpm)	Air Inclusion (cc. max.)	Fluid Loss (cc. max.)
-16	5,000	15,000	28	50	2.90	.72
-20	5,000	15,000	28	75	4.61	1.0



FD86 Series	Coupling Size	Thread Size (P)	Dimensional Data			Part Number			Line Ref.	
			A	B		Buna-N	Viton	EPR		
Male Half Female SAE O-Ring 	-16	1 <sup>5</sup> / <sub>16</sub> -12	4.03	2.11	1.75	FD86-1008-16-16	FD86-1043-16-16	FD86-1053-16-16	1	
	-20	1 <sup>5</sup> / <sub>8</sub> -12	4.16	2.48	2.25	FD86-1008-20-20	FD86-1043-20-20	FD86-1053-20-20	2	
										3
										4
										5
										6
										7
										8
										9
Female Half Female SAE O-Ring/With Wing Nut 	-16	1 <sup>5</sup> / <sub>16</sub> -12	4.62	4.50	1.62	FD86-1010-16-16	FD86-1044-16-16	FD86-1054-16-16	9	
	-20	1 <sup>5</sup> / <sub>8</sub> -12	5.22	5.25	2.00	FD86-1010-20-20	FD86-1044-20-20	FD86-1054-20-20	10	
										11
										12
										13
										14
										15
										16
Female Half Female SAE O-Ring/With Hex Nut 	-16	1 <sup>5</sup> / <sub>16</sub> -12	4.62	2.81	1.62	FD86-1006-16-16	FD86-1042-16-16	FD86-1052-16-16	17	
	-20	1 <sup>5</sup> / <sub>8</sub> -12	5.22	3.40	2.00	FD86-1006-20-20	FD86-1042-20-20	FD86-1052-20-20	18	
										19
										20
										21
										22
										23
										24



FD86 Series	Coupling Size	Thread Size(P)	Dimensional Data			Part Number			Line Ref.	
			A	B		Buna-N	Viton	EPR		
Male Half Female NPTF  	-16	1-11 <sup>1</sup> / <sub>2</sub>	4.40	2.11	1.75	FD86-1002-16-16	FD86-1040-16-16	FD86-1050-16-16	1	
	-20	1 <sup>1</sup> / <sub>4</sub> -11 <sup>1</sup> / <sub>2</sub>	4.43	2.48	2.25	FD86-1002-20-20	FD86-1040-20-20	FD86-1050-20-20	2	
										3
										4
										5
										6
										7
										8
Female Half Female NPTF/With Wing Nut  	-16	1-11 <sup>1</sup> / <sub>2</sub>	4.98	4.50	1.62	FD86-1001-16-16	FD86-1039-16-16	FD86-1049-16-16	9	
	-20	1 <sup>1</sup> / <sub>4</sub> -11 <sup>1</sup> / <sub>2</sub>	5.62	5.25	2.00	FD86-1001-20-20	FD86-1039-20-20	FD86-1049-20-20	10	
										11
										12
										13
										14
										15
										16
Female Half Female NPTF/With Hex Nut  	-16	1-11 <sup>1</sup> / <sub>2</sub>	4.98	2.81	1.62	FD86-1004-16-16	FD86-1041-16-16	FD86-1051-16-16	17	
	-20	1 <sup>1</sup> / <sub>4</sub> -11 <sup>1</sup> / <sub>2</sub>	5.62	3.40	2.00	FD86-1004-20-20	FD86-1041-20-20	FD86-1051-20-20	18	
										19
										20
										21
										22
										23
										24
<b>Repair Kit</b>	Male Half								26	
	-16					FF10596-16	FF10597-16	FF10598-16	27	
	-20					FF10596-20	FF10597-20	FF10598-20	28	
	Female Half								29	
	-16					FF10593-16	FF10594-16	FF10595-16	30	
-20					FF10593-20	FF10594-20	FF10595-20	31		

FD86 Series	Coupling Dash Size	Dimensional Size		Part Number			Line Ref.		
		A	B	Dust Cap with Chain	Dust Plug with Chain	6 Bolt Flange Assembly			
<b>Accessories</b>							1		
Dust Cap With Chain 	-16			FD86-1018-16	FD86-1016-16		2		
	-20			FD86-1018-20	FD86-1016-20		3		
Dust Plug With Chain 							4		
							5		
							6		
							7		
							8		
							9		
6 Bolt Flange Assembly* 		-16	.19	2.98			FD86-1035-16	10	
		-20	.19	3.50			FD86-1035-20	11	
									12
									13
									14
									15
							16		

\*6 Bolt Flange-holes equally spaced. (See "A" for bolt hole diameter, and "B" for bolt circle diameter.)





## FD89 Series/Flush-Face Couplings

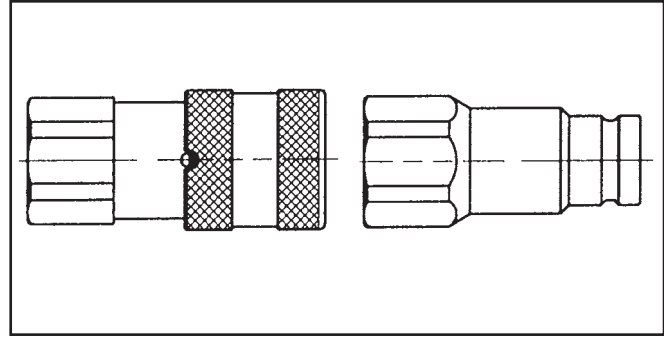
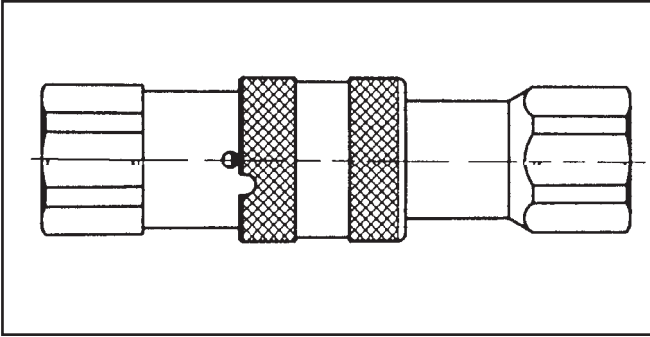
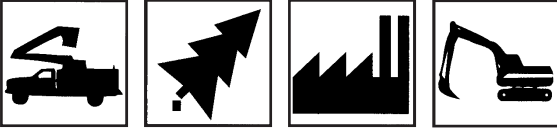

Eaton's NEW FD89 Series is specifically designed for those applications where quick and easy connections and no-spill performance are essential. Ideal for use where global interchangeability with other manufacturers is important. The FD89 Series is available in sizes from 1/4" through 2" to best meet your specific size requirements.

- Meets dimensional requirements of ISO 16028 (1/4"-1 1/4")
- Push-to-Connect Latching
- Dual Flush-Face Valving
- Safety Sleeve Lock
- Interchangeable with HTMA couplings (3/8")

### Flow Data

Pressure Drop Versus Flow

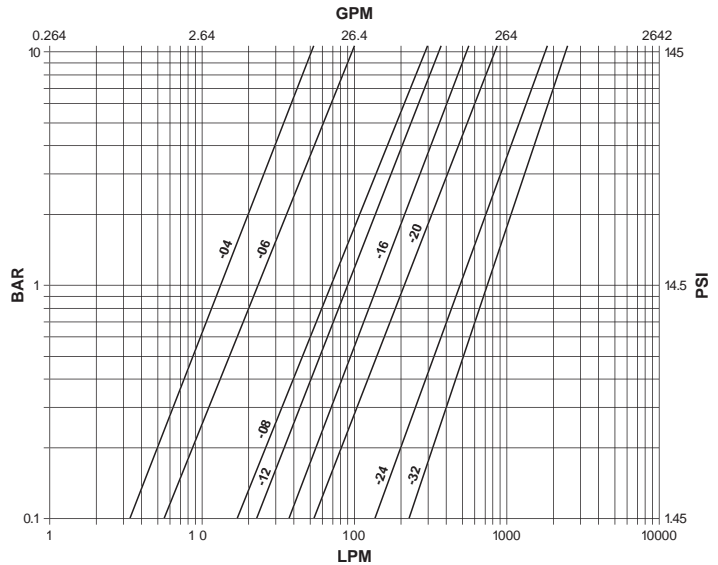

### Physical Characteristics

ISO Size	Coupling Size	Maximum Operating Pressure Connected	Maximum Operating Pressure Male Half	Maximum Operating Pressure Female Half	Minimum Burst Pressure Connected	Minimum Burst Pressure Male Half	Minimum Burst Pressure Female Half	Rated Flow	Fluid Loss	Air Inclusion	Force To Connect (No Pressure)
		PSI (BAR)	PSI (BAR)	PSI (BAR)	PSI (BAR)	PSI (BAR)	PSI (BAR)				
6,3	-04	4,350 (300)	4,350 (300)	1,740 (120)	17,400 (1,200)	17,400 (1,200)	6,960 (480)	3.2 (12)	0.006	0.005	40.2 (179)
10	-06	4,350 (300)	4,350 (300)	1,740 (120)	17,400 (1,200)	17,400 (1,200)	6,960 (480)	6.1 (23)	0.012	0.280	38.9 (173)
12,5	-08	3,625 (250)	3,625 (250)	1,450 (100)	14,500 (1,000)	14,500 (1,000)	5,800 (400)	11.9 (45)	0.020	0.040	40.7 (181)
16	-12	3,625 (250)	3,190 (220)	1,450 (100)	14,500 (1,000)	12,760 (880)	5,800 (400)	19.5 (74)	0.026	0.270	43.8 (195)
19	-16	3,625 (250)	2,900 (200)	1,450 (100)	14,500 (1,000)	11,600 (800)	5,800 (400)	26.4 (100)	0.032	0.040	50.4 (224)
N/A	-20	3,625 (250)	2,900 (200)	1,450 (100)	14,500 (1,000)	11,600 (800)	5,800 (400)	49.9 (189)	0.010	0.140	68.3 (304)
N/A	-24	2,900 (200)	2,320 (160)	1,160 (80)	11,600 (800)	9,280 (640)	4,640 (320)	76.1 (288)	0.050	0.980	96.0 (427)
N/A	-32	2,900 (200)	2,320 (160)	1,160 (80)	11,600 (800)	9,280 (640)	4,640 (320)	100.0 (379)	NA	NA	110.0 (488)



FD89 Series	Coupling Size	Thread Size (P)	Dimensional Data			Part Number	Line Ref.
			A	B	$\phi$		
<b>Male Half Female Pipe/Valved</b>  	-04	1/4-18	1.89 (47.9)		0.87 (22.0)	FD89-1002-04-01	1
	-06	3/8-18	2.36 (60.0)		0.94 (24.0)	FD89-1002-06-06	2
	-06	1/2-14	2.46 (62.5)		1.06 (27.0)	FD89-1002-08-06	3
	-08	1/2-14	2.68 (68.0)		1.26 (32.0)	FD89-1002-08-08	4
	-08	3/4-14	2.78 (70.5)		1.42 (36.0)	FD89-1002-12-08	5
	-12	3/4-14	2.78 (70.5)		1.42 (36.0)	FD89-1002-12-12	6
	-16	1-11 1/2	3.24 (82.3)		1.73 (45.0)	FD89-1002-16-16	7
	-20	1 1/4-11 1/2	3.54 (89.8)		2.17 (55.0)	FD89-1002-20-20	8
	-24	1 1/2-11 1/2	4.37 (111.0)		2.56 (65.0)	FD89-1002-24-24	9
	-32	2-11 1/2	4.87 (123.8)		2.95 (75.0)	FD89-1002-32-32	10
<b>Female Half Female Pipe/Valved</b>  	-04	1/4-18	1.89 (48.1)	1.10 (28.0)	0.87 (22.0)	FD89-1001-04-04	11
	-06	3/8-18	2.53 (64.2)	1.26 (32.0)	1.06 (27.0)	FD89-1001-06-06	12
	-06	1/2-14	2.72 (69.2)	1.26 (32.0)	1.06 (27.0)	FD89-1001-08-06	13
	-08	1/2-14	2.91 (73.8)	1.50 (38.0)	1.26 (32.0)	FD89-1001-08-08	14
	-08	3/4-14	3.18 (80.8)	1.50 (38.0)	1.42 (36.0)	FD89-1001-12-08	15
	-12	3/4-14	3.09 (78.5)	1.65 (42.0)	1.42 (36.0)	FD89-1001-12-12	16
	-16	1-11 1/2	3.67 (93.2)	1.89 (48.0)	1.73 (45.0)	FD89-1001-16-16	17
	-20	1 1/4-11 1/2	4.17 (106.0)	2.17 (55.0)	2.17 (55.0)	FD89-1001-20-20	18
	-24	1 1/2-11 1/2	5.21 (132.4)	3.15 (80.0)	2.56 (65.0)	FD89-1001-24-24	19
	-32	2-11 1/2	6.17 (156.6)	3.94 (100.0)	3.15 (80.0)	FD89-1001-32-32	20
<b>Male Half Female BSP/Valved</b>  	-04	G 1/4	1.89 (47.9)		0.87 (22.0)	FD89-1007-04-04	21
	-06	G 3/8	2.36 (60.0)		0.94 (24.0)	FD89-1007-06-06	22
	-06	G 1/2	2.46 (62.5)		1.06 (27.0)	FD89-1007-08-06	23
	-08	G 1/2	2.68 (68.0)		1.26 (32.0)	FD89-1007-08-08	24
	-08	G 3/4	2.78 (70.5)		1.42 (36.0)	FD89-1007-12-08	25
	-12	G 3/4	2.78 (70.5)		1.42 (36.0)	FD89-1007-12-12	26
	-16	G 1	3.24 (82.3)		1.73 (45.0)	FD89-1007-16-16	27
	-20	G 1 1/4	3.54 (89.8)		2.17 (55.0)	FD89-1007-20-20	28
	-24	G 1 1/2	4.37 (111.0)		2.56 (65.0)	FD89-1007-24-24	29
	-32	G 2	4.87 (123.8)		2.95 (75.0)	FD89-1007-32-32	30
<b>Female Half Female BSP/Valved</b>  	-04	G 1/4	1.89 (48.1)	1.10 (28.0)	0.87 (22.0)	FD89-1006-04-04	31
	-06	G 3/8	2.53 (64.2)	1.26 (32.0)	1.06 (27.0)	FD89-1006-06-06	32
	-06	G 1/2	2.72 (69.2)	1.26 (32.0)	1.06 (27.0)	FD89-1006-08-06	33
	-08	G 1/2	2.91 (73.8)	1.50 (38.0)	1.26 (32.0)	FD89-1006-08-08	34
	-08	G 3/4	3.18 (80.8)	1.50 (38.0)	1.42 (36.0)	FD89-1006-12-08	35
	-12	G 3/4	3.09 (78.5)	1.65 (42.0)	1.42 (36.0)	FD89-1006-12-12	36
	-16	G 1	3.67 (93.2)	1.89 (48.0)	1.73 (45.0)	FD89-1006-16-16	37
	-20	G 1 1/4	4.17 (106.0)	2.17 (55.0)	2.17 (55.0)	FD89-1006-20-20	38
	-24	G 1 1/2	5.21 (132.4)	3.15 (80.0)	2.56 (65.0)	FD89-1006-24-24	39
	-32	G 2	6.17 (156.6)	3.94 (100.0)	3.15 (80.0)	FD89-1006-32-32	40

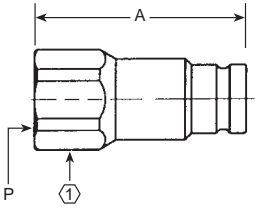
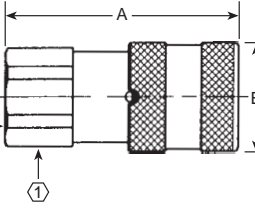

FD89 Series	Coupling Size	Thread Size (P)	Dimensional Data			Part Number Buna-N	Line Ref.
			A	B			
<b>Male Half</b> Female SAE O-Ring/Valved 	-04	9/16-18	2.00 (50.9)		0.87 (22.0)	FD89-1004-06-04	1
	-06	3/4-16	2.46 (62.5)		1.06 (27.0)	FD89-1004-08-06	2
	-06	7/8-14	2.52 (64.0)		1.18 (30.0)	FD89-1004-10-06	3
	-08	7/8-14	2.76 (70.0)		1.26 (32.0)	FD89-1004-10-08	4
	-08	1 1/16-12	2.83 (72.0)		1.42 (36.0)	FD89-1004-12-08	5
	-12	1 1/16-12	2.83 (72.0)		1.42 (36.0)	FD89-1004-12-12	6
	-16	1 5/8-12	3.24 (82.3)		1.73 (45.0)	FD89-1004-16-16	7
	-20	1 5/8-12	3.54 (89.8)		2.17 (55.0)	FD89-1004-20-20	8
	-24	1 7/8-12	4.37 (111.1)		2.56 (65.0)	FD89-1004-24-24	9
	-32	2 1/2-12	4.87 (123.8)		2.95 (75.0)	FD89-1004-32-32	10
<b>Female Half</b> Female SAE O-Ring/Valved 	-04	9/16-18	2.09 (53.1)	1.10 (28.0)	0.87 (22.0)	FD89-1005-06-04	11
	-06	3/4-16	2.72 (69.2)	1.26 (32.0)	1.06 (27.0)	FD89-1005-08-06	12
	-06	7/8-14	2.80 (71.2)	1.26 (32.0)	1.18 (30.0)	FD89-1005-10-06	13
	-08	7/8-14	3.00 (76.3)	1.50 (38.0)	1.26 (32.0)	FD89-1005-10-08	14
	-08	1 1/16-12	3.28 (83.3)	1.50 (38.0)	1.42 (36.0)	FD89-1005-12-08	15
	-12	1 1/16-12	3.29 (83.5)	1.65 (42.0)	1.42 (36.0)	FD89-1005-12-12	16
	-16	1 5/8-12	3.67 (93.2)	1.89 (48.0)	1.73 (45.0)	FD89-1005-16-16	17
	-20	1 5/8-12	4.17 (106.0)	2.17 (55.0)	2.17 (55.0)	FD89-1005-20-20	18
	-24	1 7/8-12	5.21 (132.4)	3.15 (80.0)	2.56 (65.0)	FD89-1005-24-24	19
	-32	2 1/2-12	6.16 (156.6)	3.94 (100.0)	3.15 (80.0)	FD89-1005-32-32	20

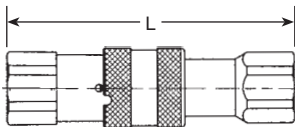
FD89 Series	Coupling Size	Connected Length (L)		Line Ref.
		NPT & BSP	SAE O-Ring	
<b>Connected Dimensions</b> 	-04	3.37 (85.5)		1
	-06-04		3.67 (93.2)	2
	-06-06	4.29 (109.0)		3
	-08-06	4.59 (116.5)		4
	-08-08	4.92 (125.0)		5
	-10-06		4.71 (119.7)	6
	-10-08		5.08 (129.1)	7
	-12-08	5.30 (134.5)		8
	-12	5.20 (132.0)		9
	-16	6.06 (154.0)		10
	-20	6.81 (173.0)		11
	-24	8.46 (215.0)		12
	-32	9.51 (241.5)		13

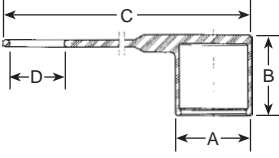
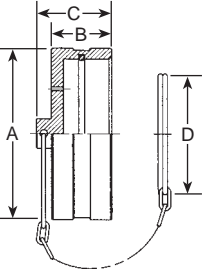
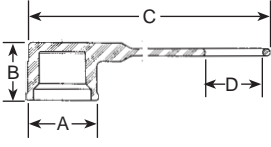
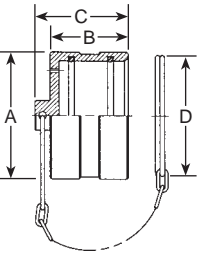

FD89 Series	Coupling Size	Dimensional Data				Part Number Buna-N	Line Ref.
		A	B	C	D		
<b>Accessories</b> Female Half Dust Cap PVC 	-04	1.26 (32)	1.50 (38)	9.41 (239)	0.79 (20)	FD89-1009-04	1
	-06	1.42 (36)	1.69 (43)	9.72 (247)	0.98 (25)	FD89-1009-06	2
	-08-08	1.65 (42)	1.81 (46)	10.10 (256)	0.98 (25)	FD89-1009-08-08	3
	-12-08	1.65 (42)	1.81 (46)	10.20 (259)	1.18 (30)	FD89-1009-12-08	4
	-12	1.81 (46)	1.97 (50)	10.43 (265)	1.18 (30)	FD89-1009-12	5
	-16	2.05 (52)	2.44 (62)	12.50 (318)	1.38 (35)	FD89-1009-16	6
	-20	2.36 (60)	2.68 (68)	13.20 (335)	1.77 (45)	FD89-1009-20	7
							8
							9
Aluminum 	-24	3.74 (95)	1.57 (40)	1.97 (50)	2.30 (58.5)	FD89-1009-24	10
	-32	4.53 (115)	1.57 (40)	1.97 (50)	2.95 (75)	FD89-1009-32	11
							12
							13
							14
							15
							16
							17
							18
Male Half Dust Cap PVC 	-04	1.10 (28)	0.91 (23)	9.06 (230)	0.79 (20)	FD89-1008-04	20
	-06-06	1.26 (32)	1.10 (28)	9.17 (233)	0.79 (20)	FD89-1008-06-06	21
	-08-06	1.26 (32)	1.10 (28)	9.25 (235)	0.98 (25)	FD89-1008-08-06	22
	-08-08	1.50 (38)	1.22 (31)	9.76 (248)	0.98 (25)	FD89-1008-08-08	23
	-12-08	1.50 (38)	1.22 (31)	9.76 (248)	1.18 (30)	FD89-1008-12-08	24
	-12	1.65 (42)	1.10 (28)	10.10 (256)	1.18 (30)	FD89-1008-12	25
	-16	1.89 (48)	1.38 (35)	12.20 (310)	1.38 (35)	FD89-1008-16	26
	-20	2.17 (55)	1.52 (38.5)	12.80 (324)	1.77 (45)	FD89-1008-20	27
							28
Aluminum 	-24	2.76 (70)	1.57 (40)	1.97 (50)	2.30 (58.5)	FD89-1008-24	28
	-32	3.35 (85)	2.05 (52)	2.44 (62)	2.95 (75)	FD89-1008-32	29
							30
							31
							32
							33
							34
							35
							36



## FD90 Series/SAE J1502 Interchange

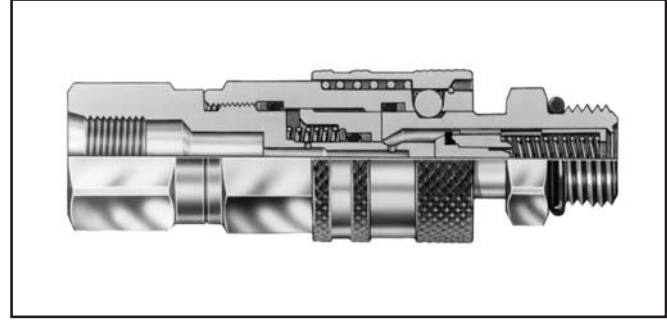
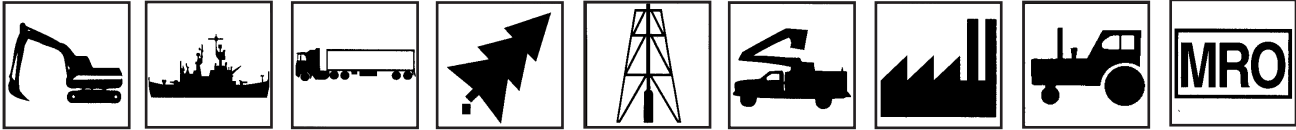

The FD90 Series diagnostic coupling is designed to connect and disconnect pressure gauges to hydraulic systems, eliminating the need for permanent gauges. The maximum operating pressure is 7,000 psi.

- Automatic sleeve for one hand push-to-connect operation.
- Flush face valving provides minimal fluid loss and low air inclusion.
- Self-sealing valve design allows connection and disconnection at 500 psi.
- Broad range of end configurations for system accessibility.
- Standard seal material – Buna-N.
- Standard seal material – Zinc plated steel.

### Physical Characteristics

Coupling Size	Maximum Operating Pressure (psi)	Minimum Burst Pressure (psi)	Vacuum (in./Hg.)	Rated Flow (gpm)	Air Inclusion (cc. max.)	Fluid Loss (cc. max.)
-04	7,000	28,000	28	.50	0.02	0.10



FD90 Series	Coupling Size	Thread Size (P)	Dimensional Data			Part Number	Part Number with Dust Cap	Line Ref.	
			A	B	$\Delta Y$	Buna-N	Buna-N		
Male Half Female Pipe/Valved  	-04	1/8-27	1.70		.62	FD90-1034-02-04	FD90-1035-02-04	1	
	-04	1/4-18	1.90		.75	FD90-1034-04-04	FD90-1035-04-04	2	
									3
									4
									5
									6
									7
									8
Male Half Male SAE O-Ring/Valved  	-04	3/8-24	1.52		.62	FD90-1044-03-04	FD90-1004-03-04	9	
	-04	7/16-20	1.58		.62	FD90-1044-04-04	FD90-1004-04-04	10	
	-04	1/2-20	1.32		.62	FD90-1044-05-04	FD90-1004-05-04	11	
	-04	9/16-18	1.32		.69	FD90-1044-06-04	FD90-1004-06-04	12	
									13
									14
									15
									16
Male Half Male Pipe/Valved  	-04	1/8-27	1.60		.62	FD90-1012-02-04	FD90-1045-02-04	17	
	-04	1/4-18	1.49		.69	FD90-1012-04-04	FD90-1045-04-04	18	
									19
									20
									21
									22
									23
									24
Male Half Metric Male O-Ring/Valved  	-04	M14x1.5	1.38		.75	FD90-1046-06-04	FD90-1047-06-04	25	
									26
									27
									28
									29
									30
									31
									31
Female Half Female Pipe/Valved  	-04	1/8-27	1.95	1.00	.75	FD90-1021-02-04	Dust Cap for Male Halves FD90-1040-04  	32	
	-04	1/4-18	2.25	1.00	.75	FD90-1021-04-04		33	
									34
									35
									36
									37
									38
									39
Female Half Female SAE O-Ring/Valved  	-04	7/16-20	2.20	1.00	.75	FD90-1041-04-04		41	
								42	
								43	
								44	
								45	
								46	
								47	
								48	

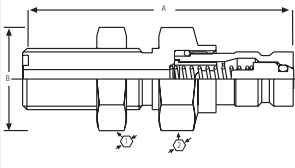
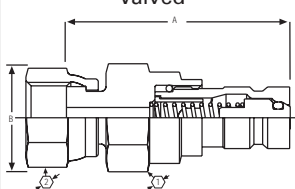
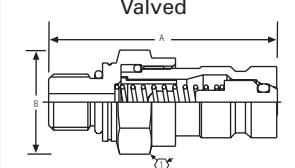

FD90 Series	Coupling Size	Thread Size (P)	Dimensional Data				Part Number Buna-N	Part Number with Dust Cap Buna-N	Line Ref.
			A	B	∠1	∠2			
Male Half Male ORS Bulkhead, Valved 	-04	9/16-18	2.46	.94	.81	.81	FD90-1206-04-04		1
									2
									3
									4
									5
									6
									7
									8
Male Half, Female ORS Swivel Valved 	-04	9/16-18	1.79	.87	.75	.69	FD90-1061-04-04		9
	-04	11/16-16	1.83	.94	.75	.81	FD90-1061-06-04		9
	-04	13/16-16	1.93	1.08	.81	.94	FD90-1061-08-04		9
									12
									13
									14
									15
									16
Male Half Male Metric O-Ring ISO6149-2 Valved 	-04	M10x1	1.58	.72	.62		FD90-1090-10-04		17
									18
									19
									20
									21
									22
									23
									24

**Eaton**  
14615 Lone Oak Road  
Eden Prairie, MN 55344  
USA  
Tel: 952 937-9800  
Fax: 952 974-7722  
[www.hydraulics.eaton.com](http://www.hydraulics.eaton.com)

**Eaton**  
20 Rosamond Road  
Footscray  
Victoria 3011  
Australia  
Tel: (61) 3 9319 8222  
Fax: (61) 3 9318 5714

**Eaton**  
Dr.-Reckeweg-Str. 1  
D-76532 Baden-Baden  
Germany  
Tel: (49) 7221 682-0  
Fax: (49) 7221 682-788



**Hydraulics**

© 2004 Eaton Corporation  
All Rights Reserved  
Printed in USA  
Document No. E-MEQD-MC001-E  
Supersedes A-MEQD-MC001-E  
July 2004